

CITY COUNCIL AGENDA ITEM
CITY OF SHORELINE, WASHINGTON

AGENDA TITLE: Neighborhood Traffic Safety Program Progress Report and Proposed Modifications
DEPARTMENT: Public Works
PRESENTED BY: Paul Haines, Director of Public Works Jesus Sanchez, Operations Manager, Public Works Rich Meredith, City Traffic Engineer

PROBLEM/ISSUE STATEMENT

The purpose of this report is to (1) provide an update of the Neighborhood Traffic Safety Program (NTSP) and (2) to propose modifications to the NTSP program.

This is in response to concerns regarding the length of time it takes for a neighborhood to go through the NTSP program.

RECOMMENDATION

Provide direction to Public Works to propose amendments to the resolution authorizing the Neighborhood Traffic Safety Program

Approved By:

City Manager  City Attorney 

This page intentionally left blank.

INTRODUCTION

The purpose of this report is to (1) provide an update of the Neighborhood Traffic Safety Program (NTSP) and (2) to propose modifications to the NTSP program.

This is in response to concerns regarding the length of time it takes for a neighborhood to go through the NTSP program.

BACKGROUND INFORMATION

The Neighborhood Traffic Safety Program (NTSP) went into effect in June 2001. Developed in partnership with the citizens of Shoreline, this program focuses on education, enforcement and engineering to improve pedestrian and driver safety on residential streets.

Excessive speeding, cut-through traffic, the lack of adequate pedestrian walkways as well as poor line of sight are the most common traffic safety issues identified by the majority of the residents in the neighborhoods represented in this program.

The program is a two phased approach. Phase I of the program educates the driver through driver awareness and targeted law enforcement. These efforts are intended to change driver behavior on the road and improve traffic safety within the residential neighborhood. Phase I also utilizes available tools such as placement of radar speed trailers, brush trimming, signage placement, and pavement.

To determine whether these efforts are effective and successful, baseline data such as the number of cut-through vehicles, the volume of traffic and vehicle speeds are collected prior to the implementation of Phase I tools, and again after implementation. If the comparison of the baseline data shows no improvement after Phase I, and if the minimum criteria (based on points) is met, the neighborhood moves into Phase 2 of the program where physical devices are considered. Some of the most common physical devices are traffic circles, speed humps, chicanes, or curb bump outs. The decision to install a physical device currently requires 70% vote of approval by the affected residences. Without this approval, installation of the physical device will not be pursued by City staff.

The NTSP was first funded in 1999 and continues to be funded through 2008. Since the inception of the program, approximately 82 residential areas have applied to the program. The following is a breakdown of the status of these residential areas:

Of the 82 residential areas that have applied to the program:

- 36 Residential Areas have **not** completed turning in their seven signatures, which is a requirement of the program.
- 41 Residential Areas are at a various stages in Phase I
- 2 Residential Area in Phase II
- 2 Residential Areas completed Phase II
- 1 Residential Area was ineligible because it was on an arterial street.

DISCUSSION

Concerns have been raised about the length of time it can take to work through the program. The length of time for a residential area to be in the NTSP program is largely dependent upon the commitment by the neighborhood, who participate with the City in moving the program forward. As defined, the NTSP program is a community and city partnership.

There are many reasons as to why the program in a specific neighborhood can remain stagnant. The most common are the contact person is unable to gather seven signatures, the contact person has moved, residents cannot find the time to participate in baseline data gathering, or just a lack of participation and interest.

These variables contribute to the length of time it may take a neighborhood to participate in Phase I and Phase 2 of the NTSP program. City staff works with the neighborhoods to assist them in completing the community selected activities in the residential area plan that is jointly developed by both the residents and City staff. **However, in order for the NTSP program to be successful, it is important for the neighborhoods to participate and have an active role in the NTSP program.**

One of the reasons behind the continued success of the NTSP program is that this program has the resources to address traffic safety issues on non-arterial streets. From the program inception in 2001 to March, 2004, we have been able to implement the following Phase 1 tools to improve driver awareness in the neighborhoods participating in the NTSP.

• Total number of hours of targeted law enforcement	1388 Hours
• Number of traffic citations issued	1526
• Number of thermoplastic stop bars installed	12
• Number of thermoplastic pavement legends installed	19
• Number of radar speed trailer location placements	700
• Number of signs installed or relocated	20

Additionally, the NTSP program provided the resources for projects in two residential areas under Phase 2 of the NTSP program.

1. Completed the closure of N. 183rd Street at Dayton Avenue North to reduce cut-through traffic.
2. Realigned the intersection of Ridgefield Road N.W. and N.W. Springdale Court to reduce the volume and speed of cut-through traffic, improving safety, and installed a speed hump south of this intersection.

In these cases, we have seen improved safety through the reduction of speeds, cut-through traffic, better visibility, and improved driver awareness. All can be attributed to the success of this program.

Three more phase 2 projects are currently scheduled for installation through the NTSP program in the fall of 2004. They are installation of traffic circles at three locations:

- N 183rd St at Wallingford Ave N.
- N 183rd St at Stone Ave N.
- 12th Ave NE at NE 152nd St.

These will be the first traffic circles used in the City of Shoreline, and have proven to be very successful in other jurisdictions.

Recommended Changes to the NTSP

Since the implementation of the NTSP program, there have been comments about some details of the program. Concerns have been raised about the length of time to get devices built and specific requirements for approval of devices. Through input from the community and our experience base, we evaluated the program and recommend some changes to clarify some points, streamline some processes, and add more features to the toolbox. These revisions are summarized in Attachment A.

On March 29, 2004 City staff met with the Technical Advisory Committee and the Citizens Advisory Committee to go over proposed modifications. These groups are made up of representatives from Police, Public Works, CRT, King County, neighborhood leaders, and other local residents. Meeting invitations were extended to all that initially worked on the development of the NTSP program. Comments from that meeting and from staff have been incorporated into the draft revisions of the NTSP.

Funding Source Discussion

Except for the Residential Parking Zone (RPZ) program, the proposed modifications to the NTSP program will not have an additional financial impact and will be funded under the existing NTSP budget. Currently, the NTSP program is allocated \$211,000 annually. Of this, \$50,000 go to the police department to fund targeted enforcement in residential and high complaint areas.

The RPZ program will have a financial impact. Please refer to the July 6, 2004 RPZ staff report under the Funding Source Discussion. In summary, costs associated with conducting parking studies, staff support for neighborhoods, material costs for signs, posts, and equipment, and labor costs for installation of signs will be funded through NTSP funds. Costs for administration-issuance, record keeping, inventory of permits, and supplies, such as applications and permit decals (regular and temporary) will be funded by fees.

Conclusions

We believe that implementing the proposed modifications will bring some efficiencies to the NTSP program. It is important to remember that this program was developed in partnership with the Shoreline citizens and that their participation is critical to the success of the program.

As we move forward, we continue to work toward meeting the goal of the NTSP program to establish procedures and techniques that:

- Improve safety on neighborhood streets
- Are easy for citizens and staff to understand and navigate
- Wisely utilize the City's financial and staff resources
- Ensure that neighborhoods are treated consistently
- Rely on neighborhood cooperation and coordination
- Does not push one neighborhood's problem into another
- Respect the importance of emergency response time.

RECOMMENDATION

Provide direction to Public Works to propose amendments to the resolution authorizing the Neighborhood Traffic Safety Program

ATTACHMENTS

Attachment A: Summary of Recommended Modifications

Attachment B: Copy of NTSP User's Manual

ATTACHMENT A

The following modifications to the program are being recommended for the Council's consideration:

- Current** – Safety assessment using the Selection and Prioritization Criteria chart is completed at the beginning of Phase 2.
Proposed – The safety assessment will be completed at the start of both phases 1 and 2. If there is a safety need, the neighborhood can consider Phase 2 devices in addition to Phase 1 tools, while working concurrently in Phase 1.
- Current** – Not addressed
Proposed – Files for residential areas that have not shown any activity over a period of 11 months will be sent a letter asking about the status of their participation, and give neighborhoods 30 days to respond. Areas that do not respond or show any activity will be closed out and considered complete.
- Current** – Approval rate of 70% of affected residents or votes returned.
Proposed – Change the approval percentage from 70% of affected residents or votes returned to 60% approval of affected residents.
- Current** – Phase 2 devices are all considered together.
Proposed – Divide the phase 2 devices into three groups, ranging from least restrictive to most restrictive. Neighborhood in phase 2 must examine or try devices in group 1 before moving to groups 2 and 3. Devices are to be grouped as follows:

<u>Group 1</u>	<u>Group 2</u>	<u>Group 3</u>
Curb Bump-Outs	Chicanes	Diverter
Entry treatment	Median - Midblock	Full Closure
Roadway Narrowing	Median - Intersection	
Traffic Signing	Partial Closure	
Traffic Circles	Raised Crosswalks	
Pedestrian Walkways	Speed Humps	
Street Lights	Residential Parking Zone	

- Proposed** – Additional Phase 1 devices:
- Pedestrian Walkways
- Street Lights
Proposed Phase 2 devices
- Residential Parking Zone (RPZ) Program
- Current** – Petitioning takes place by City Staff sending out voting sheet to each of affected residents.
Proposed – Add to the petition process “Petitions can also be circulated by neighborhood volunteers

7. **Current** – Specifies installation of temporary physical devices prior to installation of permanent physical devices.
Proposed – Change language to read that temporary devices shall only be installed for group 3 devices.
8. **Current** – Installation of a land use sign is required before installation of a physical device.
Proposed – Change to require a land use sign before and during the placement of temporary physical devices only.
9. **Proposed** – Suggested changes to **Selection and Prioritization Criteria** used for safety assessment in Phase 1 and entrance into Phase 2:
 - a. Under AWDT(Average WeekDay Traffic), Change wording -“devices not permitted” would be changed to “devices not recommended”.
 - b. Change language to read “sight distance limitations”.
 - c. Accident history would be clarified to be “average accidents per block or intersection per year.

**NEIGHBORHOOD TRAFFIC SAFETY PROGRAM
Table of Contents (continued)**

PERMANENT PHYSICAL DEVICE PETITION FORM	56
<u>APPENDIX D CITY OF SHORELINE STANDARDS</u>	<u>57</u>

Acknowledgements

The City of Shoreline would like to gratefully acknowledge the members of the Neighborhood Traffic Safety Program Citizen Advisory Committee and the Technical Advisory Committee and other professionals who provided valuable information and assistance. These participants worked closely with the City of Shoreline staff and the consultant, INCA Engineers, Inc.

Citizen Advisory Committee Members

Samuel Bess
Kathryn Ernst
Naomi Hardy
Margie King
Dale Wright

Technical Advisory Committee Members

Sarah Bohlen, City of Shoreline Planning and Development Services
Ellen Broeske, City of Shoreline Neighborhood Programs
Linda Crandall, Shoreline School District
Sargent Rob Dorman, Shoreline Police Department
Jim Edwards, INCA Engineers
Mike Gillespie, INCA Engineers
Sandy Glover, INCA Engineers
Melanie Granfors, Shoreline Fire Department
Sargent Jim Knauss, Shoreline Police Department
Karl Larson, Shoreline Fire Department
Chuck Purnell, City of Shoreline, City Engineer
Drew Robinson, Metro Transit
LaDonna Smith, City of Shoreline Customer Response Team
Kristen Stouffer-Overleese, City of Shoreline Project Engineer
Sharon Wong, City of Shoreline Traffic Technician
Rich Meredith, P.E., City of Shoreline Traffic Engineer

Neighborhood Traffic Safety Program

INTRODUCTION

Program Development, Objectives and Goals

As population continues to grow in the City of Shoreline and the neighboring communities, major roadways and intersections become more congested. As this occurs, frustrated motorists often resort to the use of local streets to bypass congested roadways or overloaded intersections. Motorists cutting-through residential neighborhoods often ignore residential speed limits, particularly when the street design accommodates higher speeds. In addition, residents within neighborhoods often speed due to street familiarity, sometimes just not noticing they are speeding.

The result is an ever-increasing number of residents expressing concerns about the safety and livability of their neighborhoods. Residents who live on these local streets perceive a danger to children playing outdoors, while others fear increased auto exhaust pollution, road noise, and hazards to walkers, joggers and bicyclists. The Neighborhood Traffic Safety Program (NTSP) was prepared to consistently and effectively address resident concerns about traffic safety in neighborhoods on residential streets.

The NTSP was developed by joint Citizen and Technical Advisory Committees which consisted of five citizen volunteers, representatives from the Shoreline Police Department, Shoreline Fire Department, King County Metro, Shoreline School District, City of Shoreline's Customer Response Team, Public Works, Planning and Development Services, and the Shoreline Office of Neighborhoods and a traffic consultant. The traffic consultant provided the Technical Advisory Committee information acquired through an intensive research effort of traffic calming techniques and procedures that are in practice around the country. Additional insights were gained on the management of traffic calming programs through a survey of communities who have well established traffic calming programs. Two public open houses were held during the development of the NTSP, and input provided at these open houses was considered by the Advisory Committees and integrated into the program if necessary.

The Advisory Committees developed this program to provide a process for identifying and addressing problems related to speeding motorists, excessive traffic volumes, accidents, and pedestrian and bicyclist safety.

The City of Shoreline recognizes that some neighborhoods will have traffic concerns on arterials; however, this program will not address arterials. Arterial issues will be addressed using other programs available within the City of Shoreline.

The goal of this program is to establish procedures and techniques that:

- ◆ Improve safety on neighborhood streets
- ◆ Are easy for citizens and staff to understand and navigate
- ◆ Wisely utilize the City's financial and staff resources
- ◆ Ensure that neighborhoods are treated consistently

- ◆ Rely on neighborhood cooperation and coordination
- ◆ Does not push one neighborhood's problems into another
- ◆ Respect the importance of emergency response time

This program was prepared using elements that have worked well in other communities, and those that the Advisory Committees determined to be most effective for the City of Shoreline. As the Advisory Committees and the City learn more about how this process works for the unique character of the City of Shoreline, the process will evolve and become more effective for our City.

The NTSP consists of a two-phase process that incorporates the "three E's": Education, Enforcement and Engineering. The *Phase 1 Program* elements generally include the Education and Enforcement elements, while the *Phase 2 Program* elements generally include the Engineering element (if needed).

Education – Successful neighborhood traffic safety programs address neighborhood concerns by changing driver behavior.

Enforcement – The use of police and neighborhood enforcement techniques to increase community awareness of speeding problems.

Engineering – Engineering review and analysis, public involvement, and the installation of physical devices for traffic calming.

Successful programs use a phased approach. Installing physical devices can be expensive and does not address the need to change driver behavior. Education can be a very effective tool to change driver behavior, making it the logical first step in the Neighborhood Traffic Safety Program.

In addition, measurements of baseline data including speeds, volumes, accident rates, and percentage of cut-through traffic are taken many times throughout the Phase 1 and Phase 2 processes to determine effectiveness of the program and to measure changes in traffic patterns.

Citizen Involvement

Under the program, the City's staff works with residents within neighborhoods to identify the types and severity of traffic problems. Residents help to develop and evaluate the various requirements, benefits, and trade-offs of NTSP projects within their own neighborhood and become actively involved in the decision-making process.

Neighborhood volunteers will be required to execute many of the *Phase 1* programs by preparing and distributing educational flyers, operating speed monitoring equipment for the Radar Reader Board and the Speed Watch Program, and assisting the City in measuring baseline data. The volunteers will be trained to use speed-monitoring equipment.

Neighborhood volunteers will also be required during the *Phase 2* process by organizing public meetings, assisting the City with petitioning for neighborhood approval of the selected physical device, and assisting the City in obtaining baseline data.

The City will solicit a citywide group of volunteers to assist neighborhood volunteers with the efforts of *Phase 1* and *Phase 2*. If you are interested in becoming a citywide volunteer, please contact the Customer Response Team at 206-546-1700.

Funding

The 2000 - 2005 Capital Improvement Program (CIP) includes funds for the development and implementation of this Program. In future years, the Capital Improvement Program will provide funds for the *Neighborhood Traffic Safety Program* based on the needs of the program.

Emergency Response

Physical devices can affect emergency response times. The public should be made aware of the effect of the particular physical device chosen by the neighborhood with input from the Fire and Police Departments. The community's need for safety on their residential streets must be balanced with the need for prompt emergency response times.

Horizontal devices, such as traffic circles, chicanes, and curb extensions, accommodate emergency vehicles better than vertical devices, such as speed humps. The physical devices also have a cumulative effect when many are within one neighborhood.

The Technical Advisory Committee has representatives from the Fire and Police Departments. The Fire and Police Departments have identified Emergency Response Routes where certain physical devices are not recommended.

In addition, the Fire and Police Departments will be consulted during the *Phase 2* development of the neighborhood's preferred design. Even though the street may not be designated an "Emergency Response Route," response times may be affected. This should be discussed with the Police and Fire Department at the first meeting in the *Phase 2* Process.

Classes

Classes are offered on the *Neighborhood Traffic Safety Program* process. During the class, participants will learn the proper usage of equipment to be used in *Phase 1* of the program. These classes are offered by the City on a regular basis. Contact the Customer Response Team at 206-546-1700 for information on the next class.

Neighborhood Traffic Safety Representative

It is the goal of the City to have a Neighborhood Traffic Safety Representative for each neighborhood. This representative is a resident of the neighborhood who has attended the class offered by the City on the *Neighborhood Traffic Safety Program* and can answer questions or be the focal point for the neighborhood traffic concerns. If you are interested in a Neighborhood Traffic Safety Representative for your neighborhood, please

work with your neighborhood association to choose a representative that will work with the Customer Response Team.

Process For Phase 1 – Education and Enforcement

The first phase of the program is education and enforcement. During this phase, the goal is to address neighborhood concerns by informing drivers of safety issues and by using traffic enforcement techniques to change driver behavior. This phase consists of ten steps.

- 1) **Citizen Complaint** – A complaint may be logged by a Citizen (referred to as the Contact) by either of the following methods:
 - ◆ Citizen calls the Customer Response Team (CRT) at 206-546-1700; or
 - ◆ Citizen obtains a Citizen Action Request Form at local libraries, police storefronts, or City website at www.cityofshoreline.com, fills it out, and mails it to CRT.

- 2) **Customer Response Team logs the complaint and investigates the situation.** The Customer Response Team in conjunction with the Neighborhood Traffic Safety Program Manager will make a determination if the issue is a candidate for the *Neighborhood Traffic Safety Program*. The issue will be a candidate if it meets the following criteria:
 - Is a non-arterial
 - Is a non-emergency
 - Can't be solved through normal maintenance practice
 - Is a neighborhood traffic safety issue

The Customer Response Team will investigate all complaints.

- ◆ If not a *Program* candidate, the issue will be referred to another program that is better suited, or if an existing program does not exist, looked at on an individual basis.
 - ◆ If it is a *Program* candidate, the Customer Response Team will send an informational package (see step 3) to the Contact. The Customer Response Team will fill out a Citizen Action Request Form, if this has not already been completed.
 - ◆ The Customer Response Team investigation will include the determination of whether or not the subject street is on an established Fire/ Police Department Emergency Response Route. This information will be used at the end of *Phase 1* and at the beginning of *Phase 2*, to help the City recommend the next step at the end of *Phase 1*. The use of certain physical devices may be restricted on established Emergency Response Routes.
- 3) **Information Package – From CRT to Contact.** If the situation is a candidate for the NTSP, the Customer Response Team will send an information package to the Contact. The package will include:
 - ◆ Letter stating that this issue is a candidate for the NTSP
 - ◆ Citizen Action Request Form (CARF) - This may be already filled out by the CRT. The Contact will be asked to add additional information if needed,

provide supportive documentation if available, and sign the completed form and return it to the CRT.

- ◆ One-sheet synopsis of program (*Phase 1 and Phase 2*) or **program brochure.**
- ◆ 25 flyers for Contact to pass out to neighbors. A minimum of seven adult residents' signatures from seven separate addresses will be required prior to going forward with the program. Flyers are to be returned to the Contact, and it will be Contact's responsibility to obtain the required number of signed flyers and forward them to the Customer Response Team. The flyers are required to verify that a problem exists and is recognized by the neighborhood, to show a commitment from the neighborhood, to get the neighborhood communicating on the issue, and to identify potential volunteers in the neighborhood.
- ◆ Flyers about the *Neighborhood Traffic Safety Program.*
 - ◆ **Here are some helpful hints for obtaining neighborhood support and signatures:**
 - Neighborhood Association. The City could come to a scheduled meeting and talk about the *Neighborhood Traffic Safety Program*, specific action, and the process.
 - Door-to-door contact.
 - Leave a flyer on doorstep with follow-up at a later time.
 - Coordinate with the neighborhood traffic representative. Ask the CRT or your Neighborhood Association President for the Contact's name and phone number.

4) **City determines boundary of affected residents.** Once the neighborhood's petition with the minimum signatures is received, the City determines the boundary of affected residents. The *Phase 1* process shall include all those residents affected or could be affected by a change in the traffic patterns.

5) **Inform all affected residents about the education/ enforcement process that is taking place in their neighborhood.**

- ◆ City will work with residents to prepare a quarterly briefing flyer as needed.
- ◆ Optional community meetings organized by the Contact.
- ◆ Educate residents on what is happening in their neighborhood and the two-phased process of the *Neighborhood Traffic Safety Program.*
- ◆ Inform Neighborhood association of traffic concerns within neighborhood.

6) **City obtains baseline data** –The City, with the help of the Contact and neighborhood volunteers, will take the following measurements to create baseline data. This information will be used to determine the severity of the issue and to gauge the effectiveness of *Phase 1* and *Phase 2* solutions.

- ◆ Measure the speed that cars are traveling on the subject street and determine the 85th percentile speed (the speed that 85 % of the cars are travelling at or below). The 85th percentile speed has been shown through numerous studies over the years as the speed that responsible drivers travel on a given section of

street. This measurement is the standard starting point used by traffic engineers throughout the United States to set the posted speed limit. However, this speed measure is not normally used to raise the speed limit in residential areas.

- ◆ Measure traffic volumes on the subject street by taking traffic counts.
- ◆ Determine the percentage of cut-through traffic by recording license plates and determining where drivers live.
- ◆ Research the accident rate along the subject street.
- ◆ Review police records of speeding citations issued and speeding complaints on the subject street.
- ◆ Perform traffic signing and pavement marking inventory.
- ◆ Photograph and/or video tape the site in question.

7) Evaluate the roadway using the Selection and Prioritization Criteria Chart. A minimum score of 11 (out of a possible 24) would allow the consideration of the use of Phase 2 group 1 devices concurrently with Phase 1.

8) **The City and neighborhood jointly develop and implement the *Phase 1* program to address the identified problem.** The program that is created will dictate the amount of time to process through *Phase 1*. It is estimated that the *Phase 1* programs will be in place for six months to one year. The *Phase 1* program, education and enforcement, may include:

- ◆ Brush Trimming or Removal
- ◆ Educational Flyers
- ◆ Pavement Markings
- ◆ Police Enforcement
- ◆ Portable Radar Trailer
- ◆ Radar Reader Board
- ◆ Rumble strips
- ◆ Signing
- ◆ Speed Watch Program

9) **Re-measure baseline data.** At the completion of *Phase 1*, the baseline data of speeds, volumes, accidents, cut-through traffic, etc. will be re-measured by the City with the help of the Contact and neighborhood volunteers to determine the effectiveness of *Phase 1*. The data gathered at the completion of *Phase 1* will be compared to the data gathered before the implementation of *Phase 1* programs to see if there has been an effective change. The new baseline data gathered at the completion of the *Phase 1* programs will be used to assign points to the street using the Selection and Prioritization Criteria. The minimum number of points for a street to qualify for *Phase 2* is 11.

10) **Hold meeting with all affected residents.**

- ◆ Discuss *Phase 1* results. Review if other Phase 1 tools would be more effective.

- ◆ Review Selection and Prioritization Criteria for *Phase 2* Physical Devices and discuss the prioritization.
- ◆ City recommendation for next step with input from citizens.

Neighborhood Traffic Safety Program Phase 1

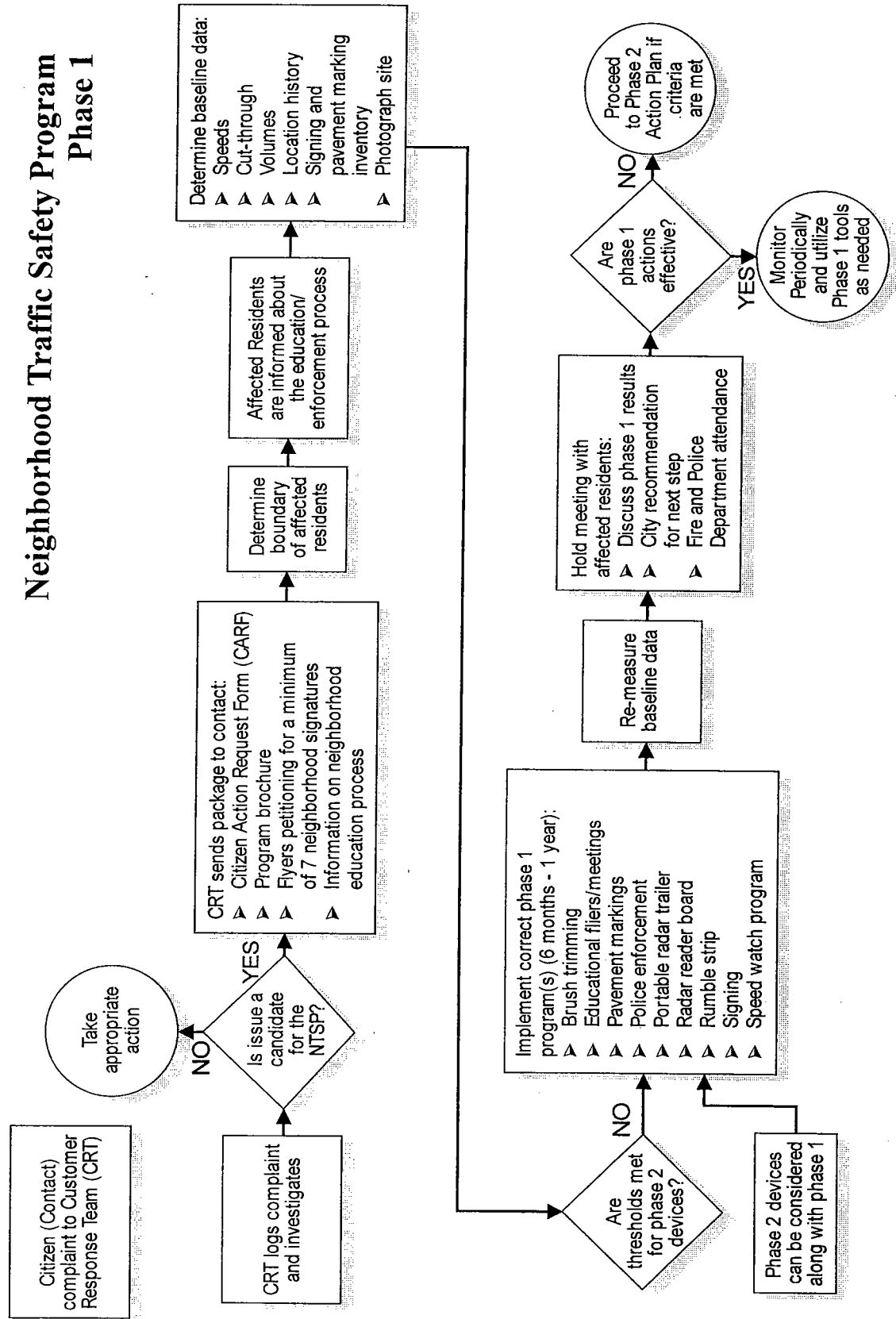

Process For Phase 2 - Engineering

The second phase of the program is engineering, and it is a nine-step process. During this phase, the goal of the program is to complete an engineering review and analysis of all the data and install necessary physical devices. The necessity for physical devices is determined at the end of *Phase 1* by using the score determined by using the Selection and Prioritization Criteria. The higher the number, the more severe the problem. A minimum score of 11 (out of a possible 24) is required prior to beginning the *Phase 2* process.

Funding shall be established prior to implementing the *Phase 2* process for a particular request. If there is more than one request that meets or exceeds the required number of 11 from the Selection and Prioritization Criteria, the neighborhood with the highest number shall have priority. If there are two or more neighborhoods tied for the highest score, the neighborhood that has been in the program the longest shall have priority.

- 1) **Public Meeting** –Reevaluate the boundary to ensure it would include all residents affected by a physical device. Upon each re-evaluation of the boundary of affected residents, the boundary area shall increase, not decrease. Ensure the residents within the boundary are notified of the meeting. The Contact and neighborhood volunteers will organize the meeting and notify the neighborhood residents. The City will attend the meeting. This meeting is not the same meeting to be held at the end of *Phase 1*.
 - ◆ Review *Phase 1* effectiveness.
 - ◆ Discuss different physical devices available and the types of concerns they address.
 - ◆ Discuss the entire process for *Phase 2* implementation.
 - ◆ May have workgroups to allow residents to work out the solutions with the help of an engineer. Have the groups discuss the problem and alternative solutions with their neighbors and report their findings to the rest of the group at a second meeting.
 - ◆ Include the Fire and Police Departments to discuss possible reduction in response times with physical devices, cumulative effect with existing physical devices, and other issues relating to specific concerns of the neighborhood layout.

- 2) **Determine technical feasibility of the physical devices selected by the neighborhood workgroups and determine the preferred alternative.** (If workgroups are out talking with their neighbors, this is to be done during that process). There is a hierarchy in the determination of the appropriate Phase 2 device. The devices have been categorized into 3 groups, with group 1 being the least restrictive to group 3 being the most restrictive. Group 1 devices will be considered before group 2 before group 3.

Physical devices may include:

<u>Group 1</u>	<u>Group 2</u>	<u>Group 3</u>
Entry treatment	Chicanes	Diverter
Curb Bump-Outs	Median - Midblock	Full Closure
Roadway Narrowing	Median - Intersection	
Traffic Signing	Partial Closure	
Traffic Circles	Raised Crosswalks	
Pedestrian Walkways	Speed Humps	
Street Lighting	Residential Parking Zone	

- 3) **Reevaluate the boundary of affected residents.** The City will determine if this has changed with the physical device type.
 - ◆ Any part of the neighborhood affected by the devices should be considered for the community meeting and for petition, including residents living on arterials.
 - ◆ If the boundary changes, repeat public meeting with all affected residents.
 - ◆ The boundary should be reviewed prior to each community meeting.

- 4) **Petition for 60% approval of affected residents, including renters and owners.**
 - ◆ Each dwelling unit, as determined by having it's own mailing address, is entitled to one petition signature. Units that are rented shall have one petition signature: one for the renter or one for the owner of the unit. In the event the renter and owner disagree, each signature can be counted as a "half" signature. Owners of multiple units will be entitled to a total of one vote only. Petitioning will take place by City staff sending out a voting sheet to each of the affected residents. Petitions can also be circulated by neighborhood volunteers. 60% approval is required of the affected households prior to going forward with the process.

- 5) **Obtain baseline data for surrounding streets.** This baseline data will be used for future comparison of traffic patterns on surrounding streets. This baseline will be used to evaluate whether traffic shifted from the subject street to adjacent streets and to what extent the traffic shifted when the physical device was installed. For determining whether a traffic issue has transferred to an adjacent street, the City of Shoreline has adopted a threshold of 150 vehicles per day; 150 vehicles per day could be added to an adjacent street before it is determined that an unacceptable traffic volume shift has occurred.

- 6) **Install temporary physical devices.**
 - ◆ Inform affected residents that they will be petitioned for a permanent device after 90 days. (City with the help of the Contact and neighborhood volunteers)
 - ◆ If a 60% majority of the residents is not for the physical device, the temporary device will be removed.

- ◆ If 60% majority of the residents is for the physical device, the temporary device will remain in place until the permanent device is installed.
- ◆ Not all devices can be installed temporarily, i.e. traffic circles.
- ◆ The City will display a land use sign to notify residents of the installation of the physical devices in group 3.

7) Take baseline measurements again to ensure temporary device is working. If proposed by the City, re-measure baseline data on surrounding streets to ensure the issue did not shift to another neighborhood street. Also, re-measure the baseline data on the subject street and insert the data into the Selection and Prioritization Criteria. A successful installation would reduce the number below 11, even though the number for accidents may not be known at this time.

8) Install permanent device.

9) Re-measure baseline measurements to ensure permanent device is working. If proposed by the City, re-measure baseline data on surrounding streets to ensure the issue did not shift to another neighborhood street. Also, re-measure the baseline data on the subject street and insert the data into the Selection and Prioritization Criteria. A successful installation would reduce the number below 11, even though the number for accidents will not be known at this time.

Important Note About Device Removal:

If neighborhood residents wish to remove a physical device after it is installed following the steps of this program, even if it is not effective, residents shall be petitioned for 60% agreement, and residents shall pay for the removal. If the device is determined to be a safety issue, the device will be removed immediately by the City at no cost to the residents.

Neighborhood Traffic Safety Program Phase 2

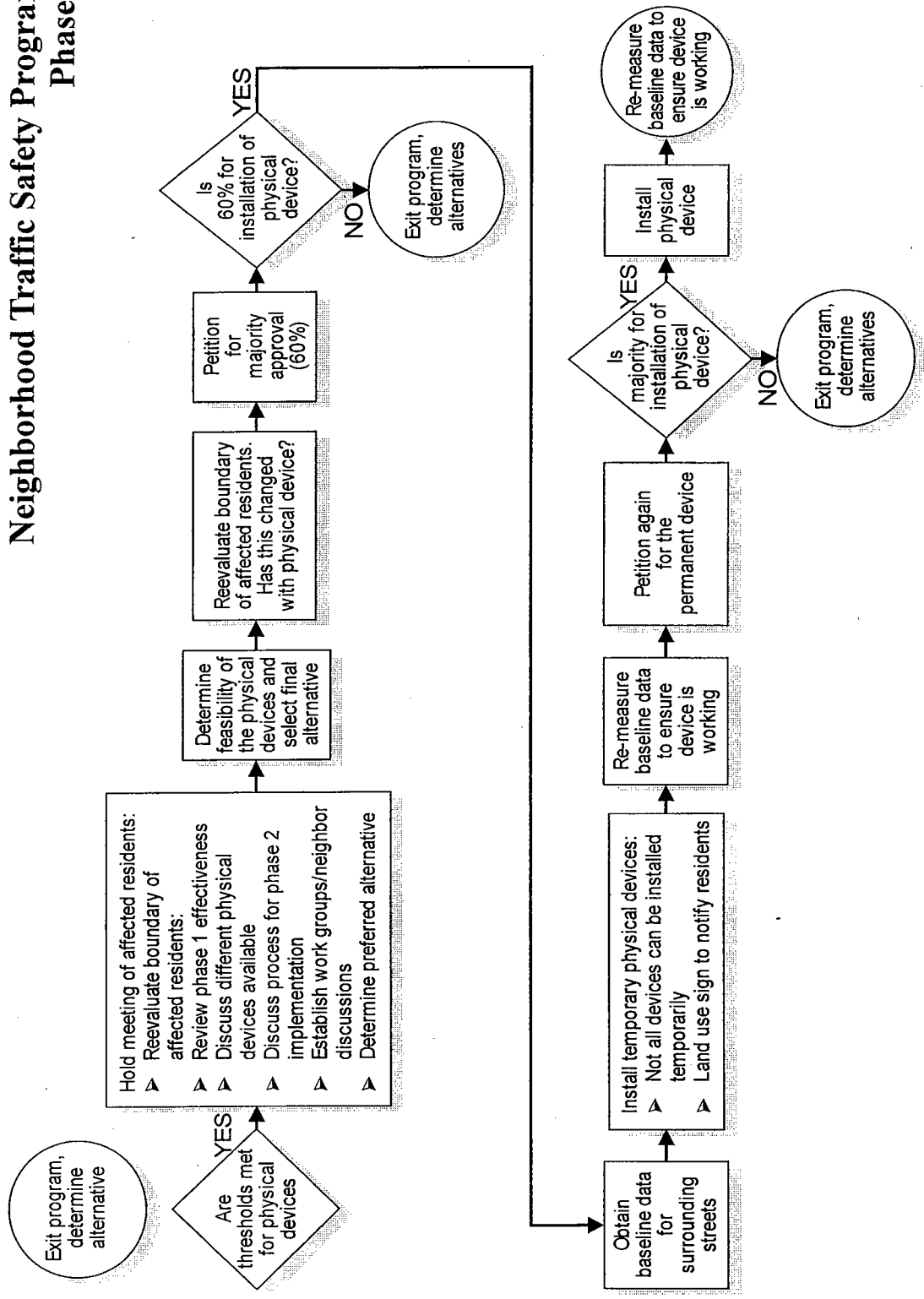

Selection and Prioritization Criteria For Phase 2 Program

Criteria	Points
Average Weekday Daily Traffic Counts (AWDT)	
Up to 700 AWDT	Devices not recommended
2500 and over	Devices not recommended
Traffic Cut-Through Volume (1)	
25.00% - 49.99%	1
50.00% - 74.99%	2
75.00% +	4
Traffic Speeds (2)	
0-5.99 mph over posted limit	0
6.00-8.99	2
9.00-10.99	4
11.00 +	6
Sight Distance Limitations (3)	
	2
Average Accident History (AAH) (4)	
0.5 – 1.0 accidents/year	1
1.1 – 1.5	2
1.6 – 2.0	3
2.1 – 2.5	5
2.6 – 3.0	6
Over 3.0	7
Street Conditions	
No sidewalks	2
Sidewalks on one side of street only	1
Parks, Schools Public or Private, K-12	
Within ¼ mile	3
Between ¼ and ½ mile	2

- 1) As a % of the total AWDT on primary roadway between arterials.
- 2) 85th percentile of all vehicles, both directions, over a 24-hour period.
- 3) Limited vertical or horizontal sight distance, such as the inability to see over a hill or around a curve. Points will be given if stopping sight distance for crest and sag curves per WSDOT Design Manual are not met.
- 4) Reported collisions over past three years at intersections and mid-block for study area.
AAH = Total Collisions/((# of Intersections + # of Mid-Block Segments)(# of Years Data))

Note: The minimum number of points required for a neighborhood to qualify for consideration is 11. All physical devices shall be subject to technical feasibility as determined by the City Engineer for the situation.

Technical Feasibility, Constraints, Guidelines and Factors Affecting Design

The following are technical aspects that should be considered when reviewing the proposed placement of a physical device.

- ◆ It must be determined that the device will work for the problem experienced.
- ◆ It must be assured that the problem will not shift to the parallel streets.
- ◆ Stopping sight distance standards should be considered prior to installing physical devices.
- ◆ Adequate provisions should be made for buses (school, metro, paratransit), garbage collection, moving vans, construction equipment, pedestrians and bicyclists where physical devices are installed.
- ◆ Check to ensure devices will allow adequate drainage.
- ◆ If curbs and gutters are not present, the design of individual traffic control devices may need to be modified to restrict drivers from using the shoulders to avoid devices.
- ◆ Physical devices should be installed on paved roadways with good surface conditions.
- ◆ Consider the grade of the roadway. Some physical devices should not be used on grades exceeding 8%.
- ◆ Emergency response times and the need to move vehicles through the area should be considered. The cumulative effect of physical devices on emergency vehicle response times should also be considered. Contact the Shoreline Fire Department and Police Department.
- ◆ Consider the effect of the device on street sweeping and other maintenance activities.
- ◆ Potential loss of on-street parking.
- ◆ Increase in or concentration of noise and air pollution levels due to the physical device.
- ◆ Potential changes to community character.
- ◆ Sight distance obstructions related to landscaping, fences, roadway alignment, grade, etc.
- ◆ Appropriate spacing between devices.

- ◆ The proximity to other calmed areas and intersections.

References

1. A Guidebook for Residential Traffic Management, Washington State Department of Transportation, December, 1994
2. Neighborhood Traffic Control, North Central Section, Institute of Transportation Engineers, December, 1994
3. Canadian Guide to Neighborhood Traffic Calming, Transportation Association of Canada, December 1998
4. Neighborhood Traffic Control Program, City of Bellevue
5. Oregon Traffic Calming Program, Portland
6. Neighborhood Traffic Safety Program, King County Department of Transportation
7. Neighborhood Traffic Management Program, City of Phoenix
8. Collier County Neighborhood Traffic Management Program

Appendix A

Phase 1 Programs

Brush Trimming or Removal

Definition: The trimming and/or removal of brush by homeowners or the City maintenance crews to allow better sight distance.



Advantages	Disadvantages
<ul style="list-style-type: none"> ◆ Low cost. ◆ Increase visibility for oncoming cars or pedestrians. ◆ Promote safety and reduce conflicts/accidents. ◆ Immediate effect. 	<ul style="list-style-type: none"> ◆ Labor cost and maintenance.

Evaluation Considerations

<i>Safety Improvement</i>	<i>Speed Reduction</i>	<i>Volume Reduction</i>	<i>Pollution</i>	<i>Cost</i>	<i>Emergency Services</i>
Yes	No	No	No Change	Low	No Effect

Educational Flyers/Meetings

Definition: Activities that inform and seek to modify driver behavior. Techniques include printed information, meetings and workshops with City staff, interaction with neighbors, signing campaign, school outreach. Involves neighborhood resident participation to prepare and pass out educational flyers, advertise, and set up meetings and workshops.

Studies have generally shown that people speeding in neighborhoods tend to be local residents.



Advantages	Disadvantages
<ul style="list-style-type: none"> ◆ Low cost. ◆ Can be relatively effective. ◆ Involves and empowers citizens. 	<ul style="list-style-type: none"> ◆ May take time to be effective. ◆ Effectiveness may decrease over time. ◆ Not likely to be as effective on non-neighborhood traffic. ◆ Can be time consuming.

Evaluation Considerations

<i>Safety Improvements</i>	<i>Speed Reduction</i>	<i>Volume Reduction</i>	<i>Pollution</i>	<i>Cost</i>	<i>Emergency Services</i>
*	*	No Effect	No Change	Low	No Effect

* Temporary improvements will occur if the majority of speeders in the neighborhood are neighborhood residents.

Pavement Markings

Definition: Addition of pavement striping to attempt to change the pattern of driver behavior on a street. May include striping for parking or bicycles lanes to give the impression of a reduced roadway width. May also include school crossings and speed limits.



Advantages	Disadvantages
<ul style="list-style-type: none"> ◆ Remains effective on occasional users. ◆ Delineation of the parking area and bicycle lane creates the impression of a narrowed roadway, reducing speed. ◆ Discourages vehicles from driving in or along the parking lane. ◆ Fewer lane conflicts. ◆ More defined driving patterns, reduced potential for accidents of the pedestrian, passing on the right, sideswipe, and parked vehicle variety. ◆ Positive community reaction. 	<ul style="list-style-type: none"> ◆ May lose its effectiveness to everyday users over time. ◆ May result in less parking due to driveway and intersection sight distance. ◆ The use of raised buttons as striping may interfere with snow removal activities. ◆ Increased maintenance costs for striping inspection and re-striping requirements.

Evaluation Considerations

<i>Safety Improvements</i>	<i>Speed Reduction</i>	<i>Volume Reduction</i>	<i>Pollution</i>	<i>Cost</i>	<i>Emergency Services</i>
*	*	No	No Effect	Low	No Effect

* Improvement will depend on the existing road and the type of striping. This will have to be determined on a case-by-case basis.

Police Enforcement

Definition: Periodic monitoring of speeding and other violations by police.



Advantages	Disadvantages
<ul style="list-style-type: none"> ◆ Good temporary public relations tool. ◆ Serves to inform public that speeding is undesirable behavior for which there are consequences. 	<ul style="list-style-type: none"> ◆ Effect is not permanent. ◆ Expensive. ◆ Budget and Manpower Constraints.

Evaluation Considerations

<i>Safety Improvements</i>	<i>Speed Reduction</i>	<i>Volume Reduction</i>	<i>Pollution</i>	<i>Cost</i>	<i>Emergency Services</i>
Yes, Temporarily	Yes, Temporarily	Not Likely	No Change	Medium to High	No Effect

Portable Radar Trailer

Definition: The mobile radar display advises motorists of their speed. It can remain at each location for 24 – 48 hours, and it can be easily moved between neighborhoods.

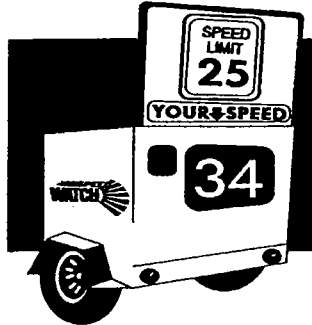

Advantages	Disadvantages
<ul style="list-style-type: none"> ◆ Heightens motorists' awareness of driving behavior and its impact on the residents. 	<ul style="list-style-type: none"> ◆ May take time to be effective. ◆ Effectiveness may decrease over time.

Evaluation Considerations

<i>Safety Improvements</i>	<i>Speed Reduction</i>	<i>Volume Reduction</i>	<i>Pollution</i>	<i>Cost</i>	<i>Emergency Services</i>
Yes, Temporarily	Yes, Temporarily	No	No Effect	Low	No Effect

Radar Reader Board

Definition: Mobile radar display advises motorists of their speed.

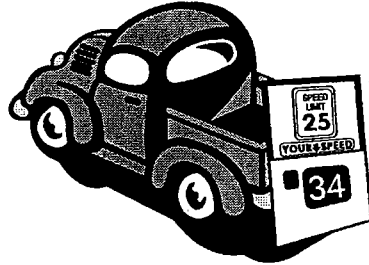

Advantages	Disadvantages
<ul style="list-style-type: none"> ◆ Educational tool. ◆ Very good public relations tool. ◆ Useful especially in school and construction zones where spot speed reduction is important. ◆ Very flexible tool. Can be easily used by neighborhood volunteers. 	<ul style="list-style-type: none"> ◆ Requires periodic enforcement. ◆ Effective for limited duration.

Evaluation Considerations

<i>Safety Improvements</i>	<i>Speed Reduction</i>	<i>Volume Reduction</i>	<i>Pollution</i>	<i>Cost</i>	<i>Emergency Services</i>
Yes, Temporarily	Yes, Temporarily	No Effect	No Effect	Low	No Effect

Rumble Strip

Definition: The installation of 4” raised buttons placed in design sequence across the roadway, causing a vehicle to vibrate, alerting the motorist to an upcoming situation. These may be used in conjunction with curves, crosswalks, pavement legends and speed limit signs. Most effective when used to alert motorists to unusual conditions ahead. Most commonly used on approaches to stop signs, often in situations where visibility of stop sign is limited. Should not be used as a speed control device, other measures are more effective

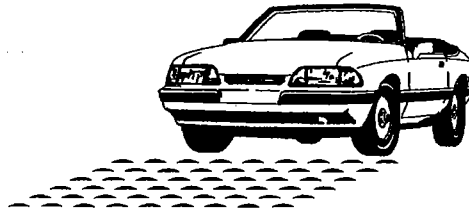

Advantages	Disadvantages
<ul style="list-style-type: none"> ◆ Relatively inexpensive to install. ◆ Creates driver awareness. ◆ May reduce speeds. 	<ul style="list-style-type: none"> ◆ May adversely impact bicyclists. ◆ Rumble strips are noisy by design, therefore placement in front of residences should be carefully considered. ◆ May interfere with snow removal activities.

Evaluation Considerations

<i>Safety Improvements</i>	<i>Speed Reduction</i>	<i>Volume Reduction</i>	<i>Pollution</i>	<i>Cost</i>	<i>Emergency Services</i>
*	*	Not Likely	Slight Increase	Medium to High	No Effect

* Improvement will depend on how device is used.

Signing

Definition: The posting of appropriate traffic control signs. These may include speed limit, parking, dead-end, school signs, etc. Stop signs will be installed only if warranted. This may also include the removal of unwarranted stop signs.



Advantages	Disadvantages
<ul style="list-style-type: none"> ◆ May provide needed information to the driver that was not provided already on the street. ◆ Typically safety improves in the long run when unwarranted signs are removed. 	<ul style="list-style-type: none"> ◆ Removal of in-place stop signs is often very difficult to accept for residents used to having them there, even when the signs are unwarranted. ◆ Oversigning an area can create a loss of effectiveness. ◆ Increased maintenance costs.

Evaluation Considerations

<i>Safety Improvements</i>	<i>Speed Reduction</i>	<i>Volume Reduction</i>	<i>Pollution</i>	<i>Cost</i>	<i>Emergency Services</i>
Potential	Potential	Not Likely	No change	Low	No Effect

Speed Watch Program

Definition: Educational program which requires the involvement and commitment from the neighborhood. Neighborhood participation includes the following:

Neighborhood participants identify motorists who drive at excessive speeds – vehicle type, color, license plate, time of day, etc. This information will be forwarded to the Shoreline Police Department for follow-up, which may include elective enforcement at the specified times, a letter, or a visit to the residence of the owner of the identified vehicle.

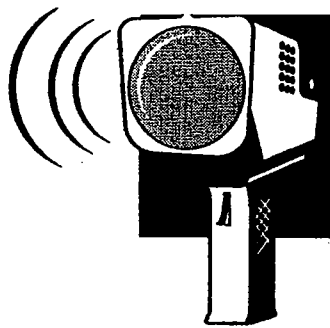

Advantages	Disadvantages
<ul style="list-style-type: none"> ◆ Promotes neighborhood involvement to address traffic issues (excessive speed as well as other community concerns). ◆ Heightens motorists' awareness of driving behavior and its impact on the residents. ◆ Provides the Shoreline Police Department with specific times for selective enforcement. ◆ Determines if traffic is cut-through. 	<ul style="list-style-type: none"> ◆ Time consuming for neighborhood residents. ◆ May take time to be effective. ◆ Effectiveness may decrease over time.

Evaluation Considerations

<i>Safety Improvements</i>	<i>Speed Reduction</i>	<i>Volume Reduction</i>	<i>Pollution</i>	<i>Cost</i>	<i>Emergency Services</i>
*	*	No	No Effect	Low	No Effect

* Temporary improvements are possible when all of the speeders receive letters from the Police Department.

Appendix B

Phase 2 Physical

Devices

Entry Treatment

Definition: Treatment to a street that includes a pavement texture, sign, banner, landscaping, planter islands, or other structure that helps to communicate a sense of neighborhood identity.

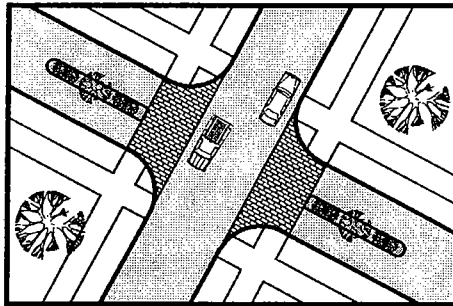

Advantages	Disadvantages
<ul style="list-style-type: none"> ◆ Positive indications of a change in environment from arterial road to residential street. ◆ Reduces entry speed. ◆ Reduces pedestrian crossing distances. ◆ On very wide streets, provides space for landscaping the median. ◆ Helps give neighborhood a sense of identity. ◆ Allows neighborhood creativity and participation in the design. 	<ul style="list-style-type: none"> ◆ Maintenance responsibility. ◆ Pavement texture is hazardous to bicyclists. ◆ High costs of repair for pavement texture. ◆ Increased maintenance for landscaping, street cleaning and curb repair. ◆ Pavement texture may interfere with snow removal activities.

Evaluation Considerations

<i>Safety Improvements</i>	<i>Speed Reduction</i>	<i>Volume Reduction</i>	<i>Pollution</i>	<i>Cost</i>	<i>Emergency Services</i>
Potential	No	No	No Effect	Medium to High	No

Curb Bump-Outs

Definition: A curb extension is a narrowing of the street, either at an intersection or at mid block, to constrain the width of the traveled way.

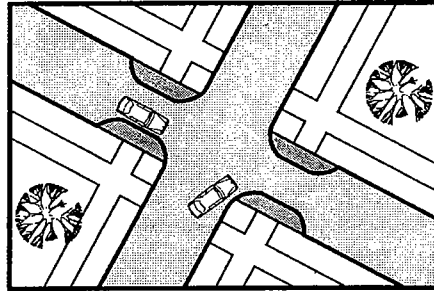

Advantages	Disadvantages
<ul style="list-style-type: none"> ◆ May be aesthetically pleasing, if landscaped. ◆ Good for pedestrian due to shorter crossing distance. ◆ Can be used in multiple applications or on a single segment of roadway. 	<ul style="list-style-type: none"> ◆ Unfriendly to cyclists unless designed to accommodate them. ◆ Landscaping may cause sight line problems. ◆ Increased maintenance if landscaped for landscaping and street sweeping. ◆ Increased maintenance for curb repair. ◆ May require removal of on-street parking.

Evaluation Considerations

<i>Safety Improvements</i>	<i>Speed Reduction</i>	<i>Volume Reduction</i>	<i>Pollution</i>	<i>Cost</i>	<i>Emergency Services</i>
Yes	Yes	Potential	Little or No Effect	Medium to High	No Effect

Roadway Narrowing

Definition: Street physically narrowed to expand sidewalks and landscaped areas.

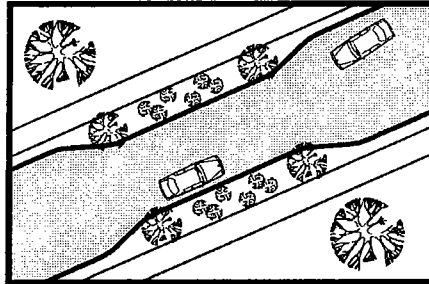

Advantages	Disadvantages
<ul style="list-style-type: none"> ◆ Minor inconveniences to drivers. ◆ Minimal inconveniences to local traffic. ◆ Reduces pedestrian crossing distances. ◆ Provides space for landscaping. ◆ Shorter crossing distances for pedestrians. ◆ Effective when used in a series. ◆ Helps slow traffic without seriously affecting emergency response time. ◆ Single lane narrowing reduces vehicle speed and through traffic. 	<ul style="list-style-type: none"> ◆ Double lane narrowing not very effective at diverting through traffic. ◆ Only partially effective as a visual obstruction. ◆ Unfriendly to cyclists unless designed to accommodate them. ◆ Conflict between opposing drivers arriving simultaneously could create problems.

Evaluation Considerations

<i>Safety Improvements</i>	<i>Speed Reduction</i>	<i>Volume Reduction</i>	<i>Pollution</i>	<i>Cost</i>	<i>Emergency Services</i>
Potential	Potential	Potential	No Effect	Medium to High	Minimal Constraint

Traffic Calming Signs

Definition: Sign informing the public that a traffic calming device(s) has been installed in the area.

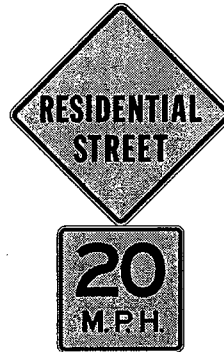

Advantages	Disadvantages
<ul style="list-style-type: none"> ◆ Informs and alerts drivers of oncoming device(s). ◆ Improves safety of the technique/device being used. ◆ Improves effectiveness of technique/device(s). 	<ul style="list-style-type: none"> ◆ More signage on the street is sometimes considered unsightly. ◆ Increased sign maintenance costs.

Evaluation Considerations

<i>Safety Improvements</i>	<i>Speed Reduction</i>	<i>Volume Reduction</i>	<i>Pollution</i>	<i>Cost</i>	<i>Emergency Services</i>
Not alone	Not alone	Not alone	No Effect	Low	None

Traffic Circles

Definition: A raised geometric control island, frequently circular, in the center of the intersection that forces traffic into circular maneuvers. Motorists yield to vehicles already in the intersection and only need to consider traffic approaching in one direction.

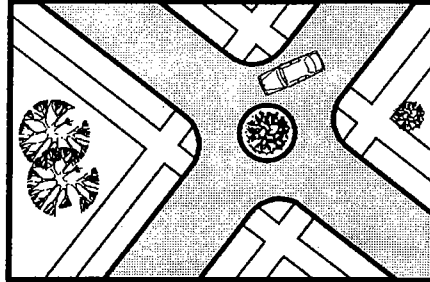

Advantages	Disadvantages
<ul style="list-style-type: none"> ◆ If there are a number of right angle accidents, a significant reduction will possibly occur. ◆ May improve streetscape if landscaped. ◆ Some vehicles may be diverted to adjacent collector or arterial streets. ◆ Speed reduction near intersection. ◆ Consider several in a row for greater effectiveness. 	<ul style="list-style-type: none"> ◆ Speed in the middle of the block may increase as some drivers try to make up for lost time. ◆ Some potential loss of on-street parking at corners. ◆ May increase volumes on other streets. ◆ Increased maintenance. ◆ Can be expensive. ◆ May want to avoid on transit routes. ◆ Avoid at intersections with high pedestrian volumes and high left-turn volumes. ◆ Avoid on designated emergency response routes, unless acceptable to emergency service. ◆ May interfere with snow removal. ◆ Increased traffic noise and air impacts from the deceleration and acceleration of vehicles.

Evaluation Considerations

<i>Safety Improvements</i>	<i>Speed Reduction</i>	<i>Volume Reduction</i>	<i>Pollution</i>	<i>Cost</i>	<i>Emergency Services</i>
Yes	Yes	Potential	Small Increase	Varies	Minor Constraints

Pedestrian Walkways

Definition: A sidewalk or path constructed of asphalt or concrete, usually installed at grade with the roadway. Can be separated from traffic by ditch, grass or gravel area, paint stripes, or curb and gutter.

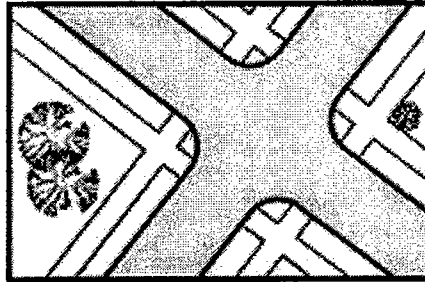

Advantages	Disadvantages
<ul style="list-style-type: none"> ◆ Asphalt paths is a lower cost alternative to concrete. ◆ Asphalt paths usually does not significantly affect drainage. ◆ Provides an all-weather path that encourages pedestrian use. ◆ Can provide an accessible route to help. ◆ Can provide an accessible route for those with mobility challenges. ◆ Allows more flexible designs ◆ Curb and gutter provide better separation between vehicles and pedestrians ◆ May improve streetscape if landscaped. ◆ Can be designed to narrow roadways to calm traffic. 	<ul style="list-style-type: none"> ◆ Can affect parking. ◆ Designs without curb and gutter can be an enforcement problem when trying to keep vehicles from parking on sidewalk. ◆ May require right-of-way or easements. ◆ Increased maintenance. ◆ Increases impervious surface of street right of way. ◆ Designs utilizing curb and gutter can affect drainage. ◆ May require a retaining wall in some locations. ◆ Increases impervious surface of street right of way

Evaluation Considerations

<i>Safety Improvements</i>	<i>Speed Reduction</i>	<i>Volume Reduction</i>	<i>Pollution</i>	<i>Cost</i>	<i>Emergency Services</i>
Yes	Potential	Potential	Small Increase	Varies	Minor Constraints

Street Lighting

Definition: Mounted high up on poles, provides illumination for roadway surfaces and sidewalks to help improve comfort, security, and safety.

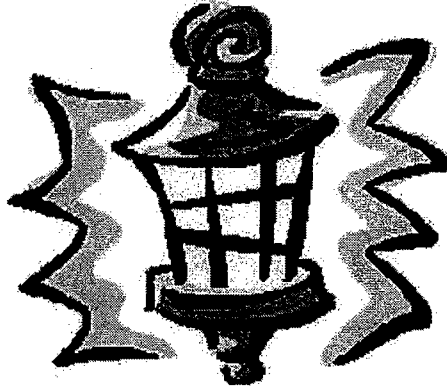

Advantages	Disadvantages
<ul style="list-style-type: none"> ◆ Improves illumination levels on sidewalks, crosswalks, and roadway surfaces. ◆ Encourages pedestrian activity in the evening and early morning hours. ◆ Improves security in neighborhoods 	<ul style="list-style-type: none"> ◆ Ongoing maintenance costs ◆ Glare can be undesirable in some neighborhoods

Evaluation Considerations

<i>Safety Improvements</i>	<i>Speed Reduction</i>	<i>Volume Reduction</i>	<i>Pollution</i>	<i>Cost</i>	<i>Emergency Services</i>
Yes	No	No	Small Increase	Varies	No

Chicanes

Definition: A series of curb extensions on alternating sides of a roadway, which narrow the roadway and require drivers to steer from one side of the roadway to the other to travel through the chicane. Typically, a series of at least three curb extensions is used.

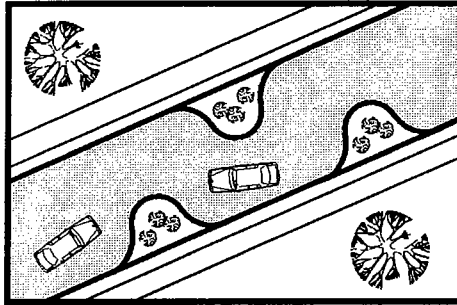

Advantages	Disadvantages
<ul style="list-style-type: none"> ◆ Imposes minimal inconveniences to local traffic. ◆ Pedestrians have a reduced crossing distance. ◆ Provides areas for landscaping. ◆ A very effective method of changing the initial impression of the street. If done correctly, drivers will not be able to see through. ◆ High public acceptance. ◆ Aesthetically pleasing. ◆ Reduces speed without significantly impacting emergency response. 	<ul style="list-style-type: none"> ◆ Increases the area of landscaping to be maintained by residents. ◆ Cost is greater than many other devices, therefore better to be installed in conjunction with street reconstruction or initial design. ◆ May create opportunities for head-on conflicts on narrow streets. ◆ May require removal of on-street parking. ◆ Should not be installed on grades greater than 8%. ◆ May increase volumes on other streets. ◆ Increased maintenance costs for street cleaning and curb repair.

Evaluation Considerations

<i>Safety Improvements</i>	<i>Speed Reduction</i>	<i>Volume Reduction</i>	<i>Pollution</i>	<i>Cost</i>	<i>Emergency Services</i>
Yes	Yes	Yes	Small Increase	Medium to High	Possible Problems

Medians – Mid Block

Definition: A mid-block median is an island or barrier in the center of a street between intersections that serves to segregate traffic. Medians create a narrower roadway and/or provide refuge for crossing pedestrians.

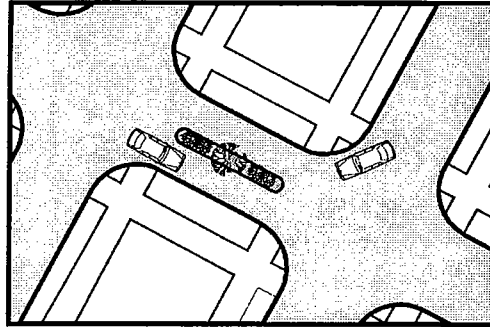

Advantages	Disadvantages
<ul style="list-style-type: none"> ◆ Provides a refuge for pedestrians and cyclists. ◆ May improve streetscape if landscaped. ◆ Provides barrier between lanes of traffic. ◆ May produce a limited reduction in vehicle speeds. ◆ Effectiveness can be increased when used with curb extensions before and after. 	<ul style="list-style-type: none"> ◆ May reduce sight lines if over-landscaped. ◆ Increased maintenance costs for landscaping, street cleaning, and curb repair. ◆ May require removal of on-street parking.

Evaluation Considerations

<i>Safety Improvements</i>	<i>Speed Reduction</i>	<i>Volume Reduction</i>	<i>Pollution</i>	<i>Cost</i>	<i>Emergency Services</i>
Slight	Potential	No	No Change	Medium to High	Possible Problems

Medians - Intersection

Definition: Barrier along the center of a roadway to prohibit left turns or cross traffic.

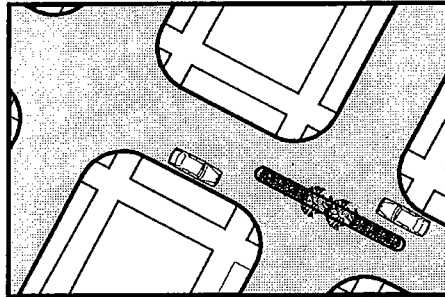

Advantages	Disadvantages
<ul style="list-style-type: none"> ◆ Provides a refuge for pedestrians and cyclists. ◆ Obstructs shortcutting or through traffic. ◆ May improve streetscape if landscaped. ◆ Provides barrier between lanes of traffic. ◆ May produce a limited reduction in vehicle speeds. ◆ Reduces vehicle conflicts. 	<ul style="list-style-type: none"> ◆ May increase volumes on other streets. ◆ May reduce sight lines if over-landscaped. ◆ Increased maintenance costs for landscaping, street cleaning, and curb repair. ◆ Reduces emergency vehicle access.

Evaluation Considerations

<i>Safety Improvements</i>	<i>Speed Reduction</i>	<i>Volume Reduction</i>	<i>Pollution</i>	<i>Cost</i>	<i>Emergency Services</i>
Yes	Potential	Yes	Decrease	Medium to High	Possible Problems

Partial Closure

Definition: Physical blockage of one direction of traffic on a two way street. The open lane of traffic is signed “One Way”.

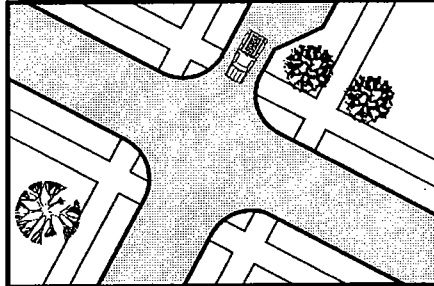

Advantages	Disadvantages
<ul style="list-style-type: none"> ◆ Reduces through traffic in one direction and possibly in the other. ◆ Allows two-way traffic in the remainder of the street. ◆ Good for pedestrians due to shorter crossing distance. ◆ Provides space for landscaping. ◆ Can be designed to provide two-way access for bicycles. 	<ul style="list-style-type: none"> ◆ Reduces access for residents. ◆ Emergency vehicles are only partially affected, as they have to drive around partial closure with care. ◆ May increase trip length for some residents. ◆ Maintenance responsibility if landscaped. ◆ May increase volumes on other streets.

Evaluation Considerations

<i>Safety Improvements</i>	<i>Speed Reduction</i>	<i>Volume Reduction</i>	<i>Pollution</i>	<i>Cost</i>	<i>Emergency Services</i>
Improved Pedestrian Crossing	Potential	Yes	Small Increase	Low to Medium	Possible Problems

Raised Crosswalks

Definition: A raised crosswalk is a modified speed hump designed at a pedestrian crossing, which can be used at mid-block locations and intersections.

Note: *Raised crosswalks must meet the same criteria as for speed humps.*

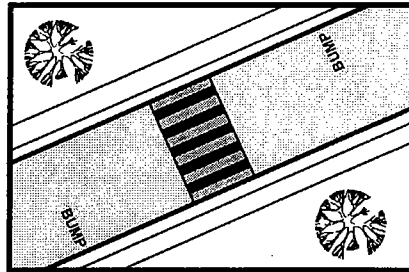

Advantages	Disadvantages
<ul style="list-style-type: none"> ◆ Effective speed control at the installation. ◆ Effective pedestrian amenity. ◆ May be designed to be aesthetically pleasing. ◆ Effectiveness may be increased when used in combination with textured crosswalks, curb extensions. 	<ul style="list-style-type: none"> ◆ May create noise, particularly if there are loose items in the vehicle or trailer. ◆ May be a problem for emergency vehicles – avoid on designated emergency response routes, unless acceptable to emergency services. ◆ May impact drainage. ◆ Drivers may speed up between installations. ◆ May increase volumes on other streets. ◆ Requires signing and striping that may be considered unsightly. ◆ May result in false sense of pedestrian security. ◆ Should not be installed on grades greater than 8%. ◆ Increased sign maintenance costs. ◆ Snow cannot be removed around humps.

Evaluation Considerations

<i>Safety Improvements</i>	<i>Speed Reduction</i>	<i>Volume Reduction</i>	<i>Pollution</i>	<i>Cost</i>	<i>Emergency Services</i>
Potential	Yes	Potential	Small Increase	Low to Medium	Possible Problems

Speed Humps

Definition: Speed humps are design features which rise above the roadway surface and extend across the roadway perpendicular to the flow of traffic. Discomfort to the driver or damage to the vehicle increases as speed over the hump increases. Best results occur when placed in a series, spacing depending on desired 85th percentile speeds between humps.

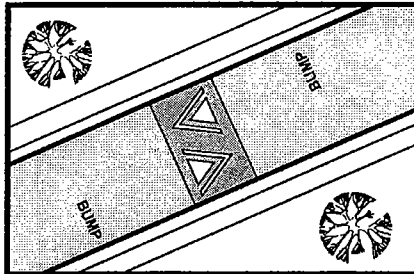

Advantages	Disadvantages
<ul style="list-style-type: none"> ◆ Reduces vehicle speeds in the vicinity of the hump. Best if used in a series at 300'-500' spacing. ◆ Self-enforcing. ◆ Relatively inexpensive. 	<ul style="list-style-type: none"> ◆ May create noise particularly if there are loose items in the vehicle or trailer. ◆ If not properly designed, drivers may try to skirt around to avoid. ◆ May be a problem for emergency vehicles. Avoid on designated emergency response routes unless acceptable to emergency services. ◆ May impact drainage. ◆ Drivers may speed up between installations. ◆ May increase volumes on other streets. ◆ Requires signage that may be considered unsightly. ◆ Should not be installed on grades greater than 8%. ◆ Increases sign maintenance costs. ◆ Snow cannot be removed around humps.

Evaluation Considerations

<i>Safety Improvements</i>	<i>Speed Reduction</i>	<i>Volume Reduction</i>	<i>Pollution</i>	<i>Cost</i>	<i>Emergency Services</i>
Potential	Yes	Yes	Increase	Low to Medium	Possible Problems

Residential Parking Zone

Definition: A designated area in a neighborhood of 5 blocks or more where residents can purchase permits that exempt them from the time limit parking restrictions in that zone.

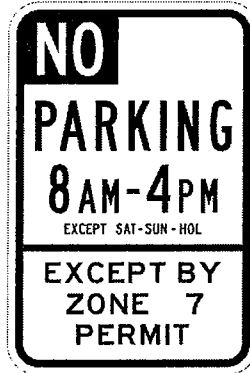

Advantages	Disadvantages
<ul style="list-style-type: none"> ◆ Can help provide more available parking for adjacent residents. ◆ Reduces the impact of major parking generators, such as hospitals, schools, and large employers, on neighborhoods. 	<ul style="list-style-type: none"> ◆ Residents must purchase permits annually. ◆ Residents must purchase temporary permits for special events. ◆ May increase parking use on other streets. ◆ Requires additional Police Dept resources to enforce the restrictions.

Evaluation Considerations

<i>Safety Improvements</i>	<i>Speed Reduction</i>	<i>Volume Reduction</i>	<i>Pollution</i>	<i>Cost</i>	<i>Emergency Services</i>
Potential	No	No	No	Varies	None

Diverter

Definition: A barrier placed diagonally across a four-legged intersection interrupting traffic flow across the intersection. This type of barrier may be used to create a maze-like effect in a neighborhood.

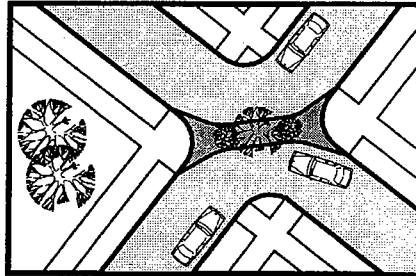

Advantages	Disadvantages
<ul style="list-style-type: none"> ◆ Eliminates through traffic. ◆ Provides area for landscaping ◆ Reduces traffic conflict points. ◆ Increases pedestrian safety. ◆ Pedestrian and bike access can be maintained. ◆ Can be designed to be mountable by emergency vehicles. 	<ul style="list-style-type: none"> ◆ Reduction in volume may increase speeds. ◆ Reduces emergency vehicles' access unless specially designed, then may be delayed slightly. ◆ Reduces access to properties for residents. ◆ May be perceived as inconvenient by some neighbors and an unwarranted restriction by the general public. ◆ May increase volumes on other streets. ◆ Increased maintenance costs for landscaping. ◆ Disruption of street grid can increase congestion on other streets.

Evaluation Considerations

<i>Safety Improvements</i>	<i>Speed Reduction</i>	<i>Volume Reduction</i>	<i>Pollution</i>	<i>Cost</i>	<i>Emergency Services</i>
Yes	Potential	Yes	No Effect	Medium to High	Possible Problems

Full Closure

Definition: Street closed to motor vehicles using planters, bollards, or barriers, etc. This could occur at either end of a street, or at a mid-block location.

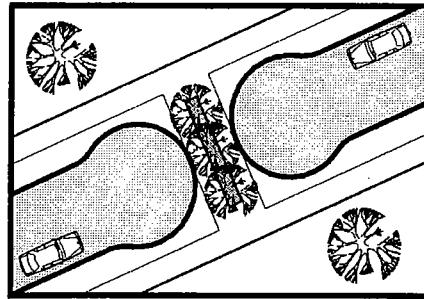
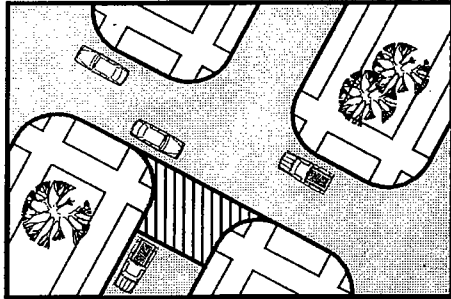

Advantages	Disadvantages
<ul style="list-style-type: none"> ◆ Eliminates through traffic. ◆ May provide areas for landscaping. ◆ Reduces speed of the remaining vehicles. ◆ Improves safety for all the street users ◆ Pedestrian and bike access can be maintained. 	<ul style="list-style-type: none"> ◆ Reduces emergency vehicle access. ◆ Reduces access to properties for residents. ◆ May be perceived as inconvenient by some neighbors and an unwarranted restriction by the general public. ◆ May increase volumes on other streets ◆ May have inadequate turn around at street end. ◆ Increased maintenance costs for landscaping.

Evaluation Considerations

<i>Safety Improvements</i>	<i>Speed Reduction</i>	<i>Volume Reduction</i>	<i>Pollution</i>	<i>Cost</i>	<i>Emergency Services</i>
Yes	Yes	Yes	No Increase	Low to Medium	Possible Problems

Appendix C

Sample

Forms/Letters

- ◆ Citizen Action Request Form (CARF)
- ◆ NTSP Acceptance Letter
- ◆ NTSP Brochure
- ◆ NTSP Flyer Petition
- ◆ Sample Educational Flyer
- ◆ Sample Petition for Temporary and Permanent Physical Devices

**Citizen Action Request Form
for the
Neighborhood Traffic Safety Program**

Contact Name _____ Day Phone _____

Address _____ Zip Code _____

Concerned Location _____

Neighborhood _____

What concerns have you identified with the above location? Certain Times of the Day?

What, in your opinion, is the root cause of the problem?

Thank you for taking the time to complete the Citizen Action Request Form. Please send the completed form to:

City of Shoreline
Customer Response Team
17544 Midvale Avenue N
Shoreline, WA 98133-4921

Once we receive the form, a representative of the Customer Response Team will investigate your street and will contact you with additional information. If you have questions or comments, please call the Customer Response Team at (425) 546-1700.

FOR OFFICE USE ONLY

Date Received _____ Project Number Assigned _____

Field Review _____

Possible Issues: _____

Accidents Speeds Volume Cut-through

Candidate for NTSP? Yes No

If no, what existing program best fits this issue _____

Sample Letter to Contact

_____ (Date)

RE: Neighborhood Traffic Safety Program, Project No. _____

Dear _____:

Thank you for contacting the Customer Response Team (CRT) about your concerns for traffic safety in your neighborhood. The City of Shoreline shares your concerns about the impact of vehicular traffic on residential neighborhoods.

The CRT has determined that your neighborhood is a candidate for the Neighborhood Traffic Safety Program (NTSP). Enclosed are the following materials:

- A two-page synopsis on the Neighborhood Traffic Safety Program
- A copy of the Citizen Action Request Form – this form was either completed by you or a CRT representative. Please check for accuracy and completeness. If you would like to add additional information, please do so and return to the CRT.
- 25 flyers for you to pass out to your neighbors. Seven (7) residents' signatures will be required prior to going forward with the program. Signed flyers should be returned to you. Once you receive the required signatures, please forward the copies to the CRT.

Entering into the *Neighborhood Traffic Safety Program* requires a commitment from you and your neighborhood to make the program work. *Phase I* requires volunteers to implement and carry out programs. Your work on letters and setting up and arranging community meetings will be crucial to the success of the program.

A *Neighborhood Traffic Safety Program* class is offered the first _____ of every month. This class will help you understand the *Neighborhood Traffic Safety Program* process, how the program works, ideas on how to be most effective with the program, and teaches the use of radar equipment. Please call the CRT for additional information.

Thank you for your inquiry. If you have any questions or additional concerns, please do not hesitate to contact the CRT at 206-546-1700.

Sincerely,

Rich Meredith, P.E.
Neighborhood Traffic Safety Program
City Traffic Engineer

Enclosures

cc: Sharon Wong, Traffic Services
Sandy Chastain, Neighborhoods Coordinator

Neighborhood Traffic Safety Program
City of Shoreline
July, 2004

48

74

Sample Brochure

WHAT IS THE NEIGHBORHOOD TRAFFIC SAFETY PROGRAM?

The Neighborhood Traffic Safety Program was created in 2000. The program addresses neighborhood traffic safety concerns by enabling Citizens and/or community groups to become involved with the improvement process.

By this method, the Customer Response Team, Public Works Department, City of Shoreline Police Department, and the neighborhood community work together to create a pleasant and safe environment in which to live.

WHY WOULD OUR NEIGHBORHOOD BECOME INVOLVED?

There could be many reasons. Some major ones include:

- Vehicles travelling faster than the posted speed limit
- Non-local traffic using the neighborhood as a shortcut
- High number of traffic accidents
- Pedestrian Safety

Fortunately, residents and business have ways they can work together to reduce speeding on neighborhood streets. Neighborhood education projects (included in *Phase 1* Programs) are effective and inexpensive and can be conducted by volunteers.

HOW DOES THE PROGRAM WORK?

The program involves a two-phase process. Depending on the nature of the problem, some solutions can be resolved and action taken immediately, while others may take longer.

Phase 1

The first phase measures the extent of the problem and focuses on using effective but less restrictive measures first. Doing so allows the opportunity to change driver behaviors and correct problems *without* imposing severe and drastic and perhaps expensive changes.

- Citizen Action Request Form
- Customer Response Team Review **1 month**
- Petition for 7 neighbor signatures to begin process
- Organize neighborhood volunteers and develop traffic management plan **1-2 months**
- Implement Traffic Management Plan **6 months – 1 year**
- Review Plan results... **1 month**
- Determine selection and prioritization criteria number (if Phase 1 not effective)
- Hold Community meeting

Phase 2

The second phase focuses on physical measures. These are *only necessary or desirable, if the Phase 1 improvements are ineffective*. A minimum score of 11 is required per the Selection and Prioritization Criteria prior to entering *Phase 2*. The highest scores will get first priority going into the *Phase 2* process.

- Review *Phase 1* Improvements .. **1 month**
- Public meeting... **1 month**
- *If necessary*, develop traffic control measures ... **1 –2 months**
- A petition is circulated by neighborhood with at least a 60% percent majority required **1-2 months**
- Group 3 devices only - Install temporary traffic control measures
- Group 3 devices only - Re-petition by neighborhood with at least 60% majority required
- Group 3 devices only - If approved by the neighborhood and the City Council, permanent traffic control

HOW DOES OUR NEIGHBORHOOD BEGIN THE PROCESS?

1. Identify the **PROBLEMS** in your neighborhood. For example:
 - Limited visibility or sight distance
 - Unusually high traffic volumes
 - Speeding vehicles
 - Pedestrian safety issues
2. **FILL OUT** the Citizen Action Request Form enclosed. (if this has not been completed already)
3. Obtain seven (7) signatures from the neighborhood. Flyers are provided by the Customer Response Team.
4. Attend the Neighborhood Traffic Safety Program class offered the first _____ of every month. This class will help you understand the Neighborhood Traffic Safety Program process, how the program works, ideas on how to be most effective with the program, and teaches the use of radar equipment. Call the Customer Response Team at 206-546-1700 to register.

IS THE PROGRAM SUCCESSFUL?

The most successful efforts occur where the neighborhood establishes traffic safety as a community priority and becomes actively involved. By working as a community, you have taken the first step toward a more pleasant and safer neighborhood in which to live.

Sample Flyer Petition for Beginning NTSP Process

NEIGHBORHOOD TRAFFIC SAFETY PROGRAM

Hello. My name is _____ and I am your neighbor.

I am concerned about the (insert specific traffic issue) in our neighborhood. I have contacted the City of Shoreline Customer Response Team, and it has been determined that our street/neighborhood is a candidate for the Neighborhood Traffic Safety Program.

The Neighborhood Traffic Safety Program is a two-phased approach to reducing traffic concerns on neighborhood streets. The first phase uses effective, but non-restrictive measures, using education and enforcement to change driver behaviors. The second phase focuses on physical measures and are only necessary or desirable if the first phase improvements are ineffective.

Seven neighbor signatures, one per household, are required prior to beginning the process. If you agree that the issues stated above exist in our neighborhood, please sign below with your address and phone number and return to me at:

Address

Name _____

Address _____ Phone Number _____

Signature _____

The program is conducted by volunteers in their spare time with the help of the City of Shoreline. Please check here if you are interested in volunteering.

YES! I am interested in volunteering.

Sincerely,

Sample Educational Flyer

Recently, the citizens in our neighborhood have become aware of a speeding problem on *(insert street name)*. We are very concerned about the safety of our children, our neighbors, and ourselves.

The *(insert name of Homeowners' Association, development, or neighborhood)* is asking that each of you remind your family members (including teen drivers in your family), your neighbors, friends, and visitors of the 25-mile-per-hour speed limit on residential streets. Speed limits are established for the safety of all, both for those on foot, as well as for those who are driving. Residential streets are not designed for high-speed traffic, and it is important that everyone drive with caution. We hope that you will encourage others to drive at or below the posted speed when traveling our neighborhood streets.

We should all work together to make our neighborhood streets safe and thereby ensure that our neighborhood remains a pleasant environment in which to live.

If you have any questions or comments about our attempts to eliminate speeding on our neighborhood streets, please do not hesitate to contact *(contact person's name and number – this is optional)*.

NOTE: *Please mail a copy of your final flyer to the Customer Response Team and reference your project number.*

City of Shoreline
Customer Response Team
1754 Midvale Avenue N
Shoreline, WA 98133-4921

Neighborhood Traffic Safety Program Temporary Physical Device Petition Form

TO: Customer Response Team
City of Shoreline

DATE:

FROM: The residents of

(name of roadway(s))

SUBJECT: Physical Devices

The traffic condition(s) (state traffic safety concern of neighborhood, i.e. motorists speed, bybass traffic, etc.) on (name of roadway(s)) is/are a concern to our neighborhood. Consequently, we are requesting, via this petition form, the City of Shoreline install temporary physical devices to mitigate the traffic concerns on our streets.

It is our understanding that the requested physical devices will require staff time and budgeting and will only be undertaken if 60% of the residents and property owners in the designated boundary have signed this petition form (only one signature per household is counted.).

NAME

ADDRESS

SIGNATURE

**Neighborhood Traffic Safety Program
Permanent Physical Device Petition Form**

TO: Customer Response Team
City of Shoreline

DATE:

FROM: The residents of

(name of roadway(s))

SUBJECT: Physical Devices

The temporary physical devices previously installed are acceptable as placed on (name of roadway(s)) is/are a concern to our neighborhood. Consequently, we are requesting, via this petition form, the City of Shoreline install permanent physical devices to mitigate the traffic concerns on our streets.

It is our understanding that the requested physical devices will require staff time and budgeting and will only be undertaken if 60% of the residents and property owners in the designated boundary have signed this petition form.

NAME

ADDRESS

SIGNATURE

Appendix D

City of Shoreline

Standards

- ◆ Traffic Circle – Design Criteria
- ◆ Traffic Circle – Asphalt
- ◆ Traffic Circle – Concrete
- ◆ Chicane
- ◆ Speed Hump
- ◆ Curb Bulb-Outs
- ◆ Traffic Circle - Signing

INTERSECTION DIAGRAM

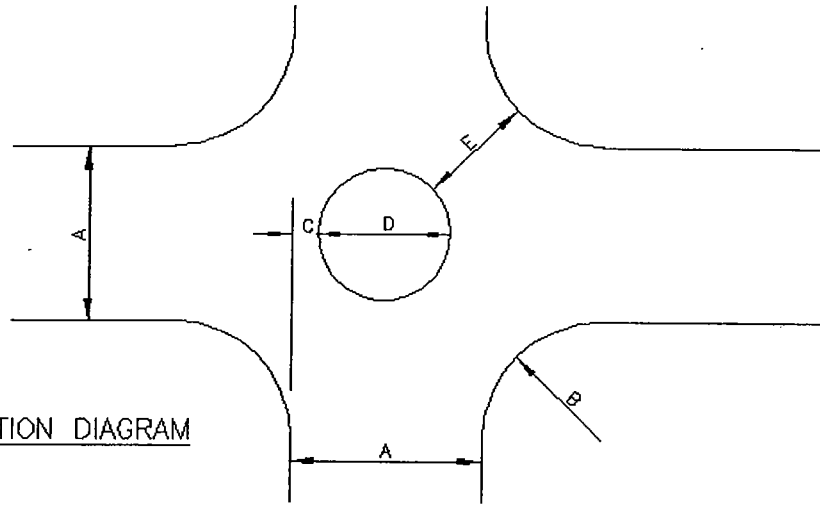

A STREET WIDTH	B CURB RETURN RADIUS	C OFF-SET DISTANCE	D CIRCLE DIAMETER	E OPENING WIDTH
20'	<15'	RECONSTRUCT CURBS		
	15'	5.5'	9'	16'+
	18'	5.0'	10'	17'+
	20'	4.5'	11'	18'+
	25'	4.0'	12'	19'+
24'	<12'	RECONSTRUCT CURBS		
	12'	5.5'	13'	16'
	15'	5.0'	14'	17'-
	20'	4.5'	15'	18'+
	25'	3.5'	17'	20'-
25'	<12'	RECONSTRUCT CURBS		
	12'	5.5'	14'	16'+
	15'	5.0'	15'	17'-
	18'	4.5'	16'	18'-
	25'	4.5'	16'	18'+
30'	10'	5.5'	19'	18'+
	12'	5.0'	20'	17'-
	15'	5.0'	20'	17'+
	18'	4.5'	21'	18'+
	25'	4.0'	22'	19'+
32'	10'	5.5'	21'	16'+
	12'	5.0'	22'	17'-
	15'	4.5'	23'	18'-
	18'	4.0'	24'	19'-
	25'	4.0'	24'	19'+
38'	10'	5.0'	26'	17'-
	12'	5.0'	26'	17'+
	15'	4.5'	27'	18'+
	18'	4.0'	28'	19'+
	25'	3.5'	29'	20'-
40'	10'	5.0'	30'	17'+
	12'	4.5'	31'	18'+
	15'	4.0'	32'	19'-
	18'	3.5'	33'	20'-
	25'	3.0'	34'	20'

**OPTIMUM
CRITERIA**

OFF-SET DISTANCE	OPENING WIDTH
5.5' MAX.	16' MIN.
5.0'	17' ±
4.5'	18' ±
4.0'	19' ±
3.5' OR LESS	20'

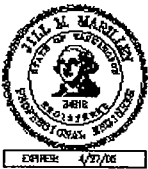
 Public Works Planning and Development Services	 BILL M. MARLEY PROFESSIONAL ENGINEER LICENSE NO. 24818 EXPIRES 4/30/06	<h2>Traffic Circle</h2> <p style="font-size: small;">This document has been signed electronically in accordance with WAC 198-23-070 and Chapter 9-34 RCW. Unauthorized alteration of any of the information on this document will invalidate the document, my certification and signature.</p>	<h1>210</h1> <p>NOT TO SCALE</p> <p>Revision Date December 2003</p>
---	--	--	---

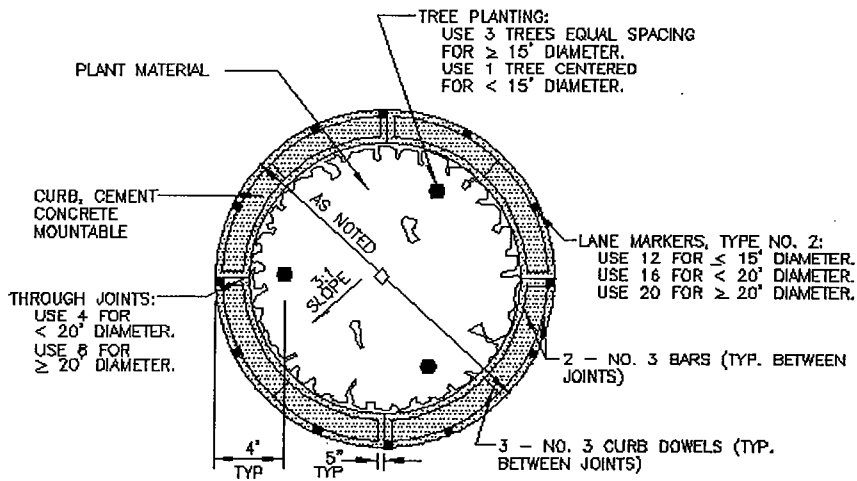

TYPICAL CONCRETE TRAFFIC CIRCLE

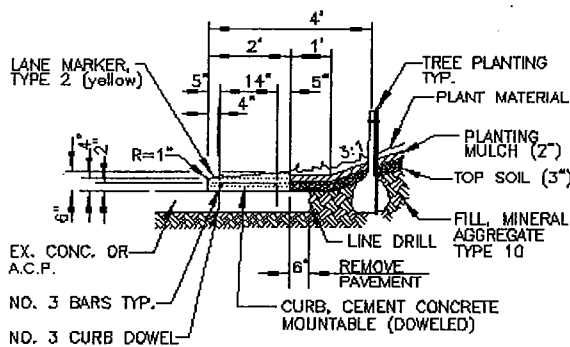

TYPICAL SECTION A

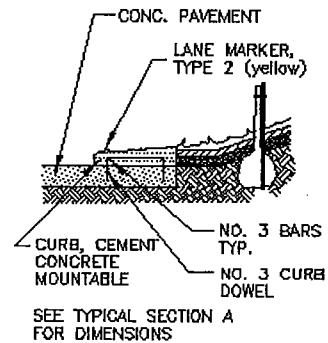

TYPICAL SECTION B



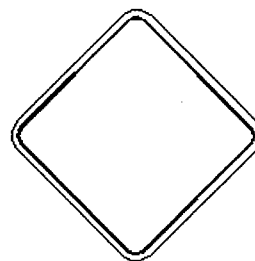

W17-81A

30" x 30" BLACK ON YELLOW
PLACED 75' TO 150' BACK
FROM TRAFFIC CIRCLE ON
EACH APPROACH.





W17-81

30" x 30" YELLOW
PLACED IN CENTER
OF TRAFFIC CIRCLE
FOR EACH APPROACH.

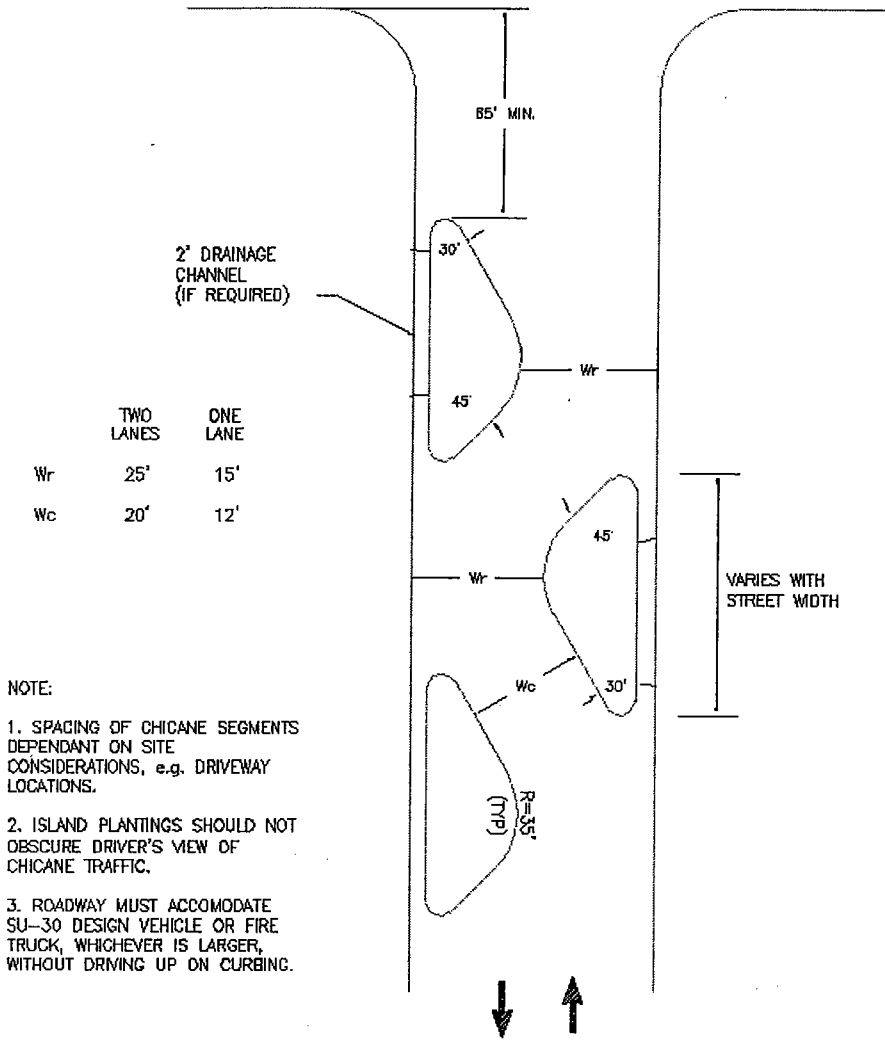
 <p>Public Works Planning and Development Services</p>	 <p>EDRER 4/27/04</p>	<h2>Concrete Traffic Circle Details</h2>	<p>211</p>
			<p>NOT TO SCALE</p>
		<p>This document has been signed electronically in accordance with WAC 180-23-070 and Chapter 9-24 RCW. Unauthorized alteration of any of the information on this document will invalidate the document, my certification and signature.</p>	<p>Revision Date December 2003</p>



	Public Works Planning and Development Services		<h1>Chicane</h1>	<h1>212</h1>
				NOT TO SCALE
<small> This document has been signed electronically in accordance with WAC 198-23-070 and Chapter 9.34 RCW. Unauthorized alteration of any of the information on this document will invalidate the document, my certification and signature. </small>			<small> Revision Date December 2003 </small>	

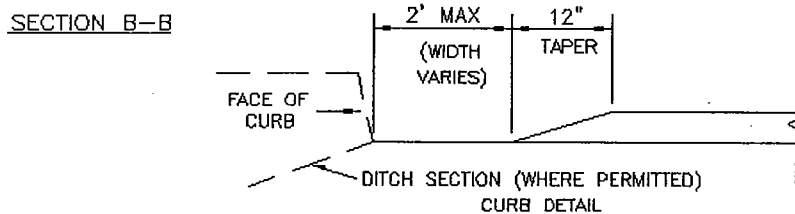
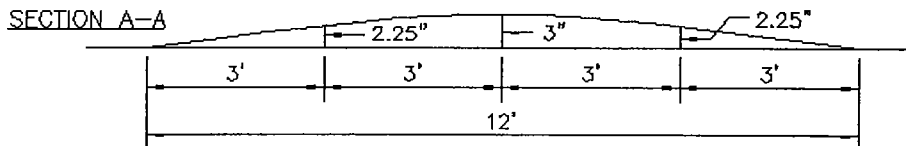
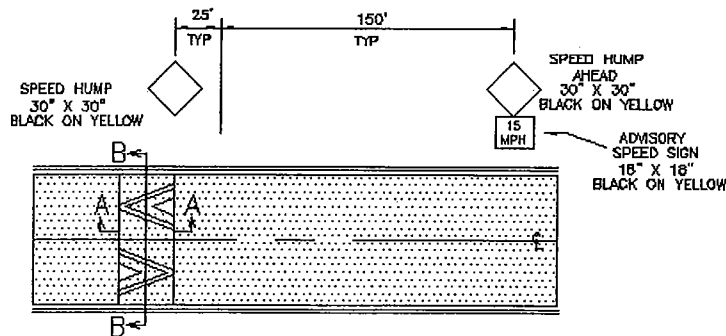
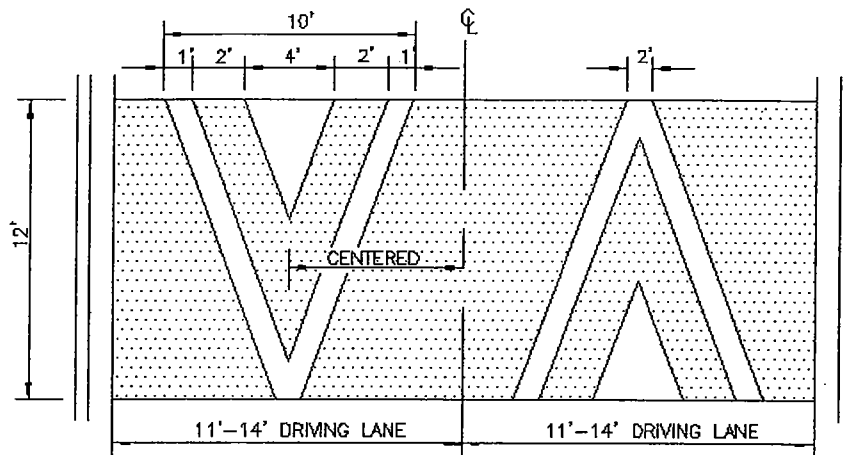

NOTES:

1. SIGN & LEGEND LOCATION SHALL BE VERIFIED BY THE TRAFFIC ENGINEER PRIOR TO INSTALLATION.
2. LEGEND & 'V' MARKINGS TO BE THERMOPLASTIC.

	<p>Public Works Planning and Development Services</p>		<p>Speed Hump: Design Pavement Marking, & Signing</p>	<p>213</p>
			<p><small>This document has been signed electronically in accordance with WAC 196-23-070 and Chapter 9.34 RCW. Unauthorized alteration of any of the information on this document will invalidate the document, my certification and signature.</small></p>	<p>NOT TO SCALE Revision Date December 2003</p>

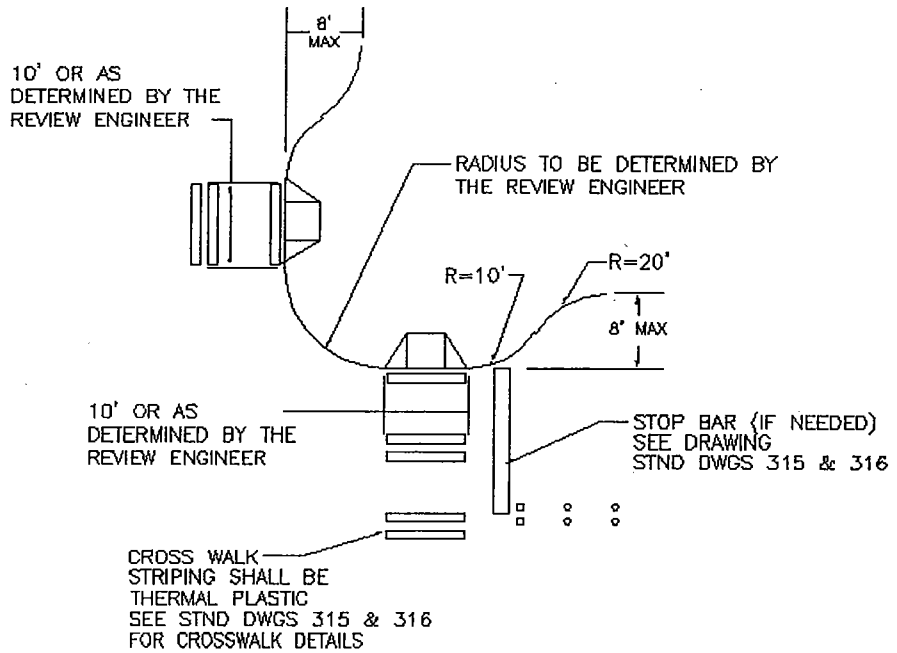

NOTES:

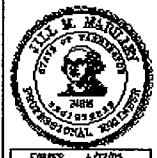

1. INTERSECTION RADII SHALL ACCOMMODATE DESIGN VEHICLES APPLICABLE TO STREET.
2. LENGTH OF CURB EXTENSIONS MUST RECOGNIZE SITE CONDITIONS, E.G. DRIVEWAY LOCATIONS.
3. IF CURB EXTENSIONS ARE PLACED ON DIAGONALLY OPPOSITE CORNERS OF AN INTERSECTION, A MINIMUM CLEAR OFFSET BETWEEN EXTENSIONS OF 15' SHOULD BE PROVIDED TO MINIMIZE VEHICULAR CONFLICTS WITHIN THE INTERSECTION.
4. ALL CURB EXTENSIONS SHALL BE APPROVED BY CITY TRAFFIC ENGINEER OR DESIGNER.

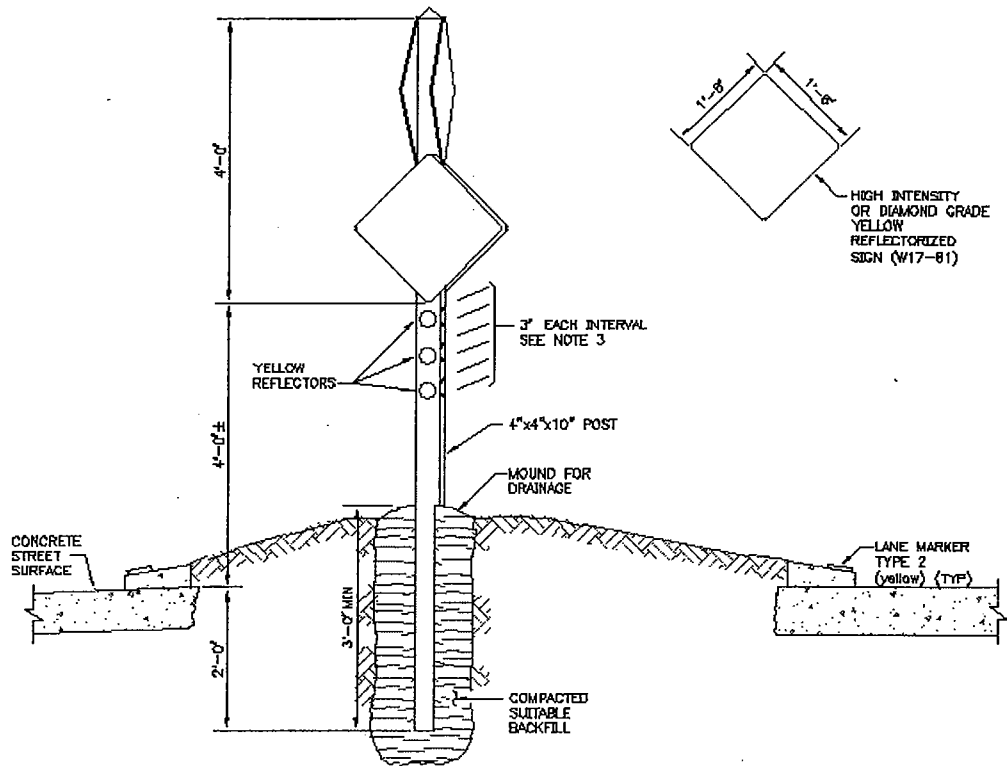
 CITY OF SHORELINE	Public Works Planning and Development Services		<h2 style="margin: 0;">Curb Extension</h2>	<h1 style="margin: 0;">314</h1>
			This document has been signed electronically in accordance with WAC 196-22-079 and Chapter 8.34 RCW. Unauthorized alteration of any of the information on this document will invalidate the document, my certification and signature.	NOT TO SCALE Revision Date December 2003



NOTES:

1. IN THE CASE WHERE ALL APPROACHES OF THE INTERSECTION ARE PRIMARILY AT THE SAME LEVEL WITH RESPECT TO GRADES (LESS THAN 3%) THE LOWER SET OF SIGNS WILL FACE THE HIGHER VOLUME STREET.
2. IN THE CASE WHERE AN APPROACH HAS A GRADE LARGER THAN 3% THE HIGHER SIGNS WILL FACE THE APPROACH WITH THE HIGHEST GRADE TO ALLOW BETTER SIGHT DISTANCE.
3. PLACE A MINIMUM OF THREE (3) REFLECTORS ON EACH AND EVERY SIDE OF POST OR PLACE THREE (3) HIGH INTENSITY REFLECTORIZED STRIPS COMPLETELY AROUND POST.

 CITY OF SHORELINE	Public Works Planning and Development Services	 STATE OF FLORIDA PROFESSIONAL ENGINEER EXP. 4/27/06	<h2 style="margin: 0;">Object Marker Installation</h2>	<h1 style="margin: 0;">512</h1>
				NOT TO SCALE
This document has been signed electronically in accordance with WAC 19B-23-470 and Chapter 9.34 RCW. Unauthorized alteration of any of the information on this document will invalidate the document, my certification and signature.				Revision Date December 2003

This page intentionally left blank.