

CEMENT CONCRETE PAVEMENT - DOWEL BAR JOINTS

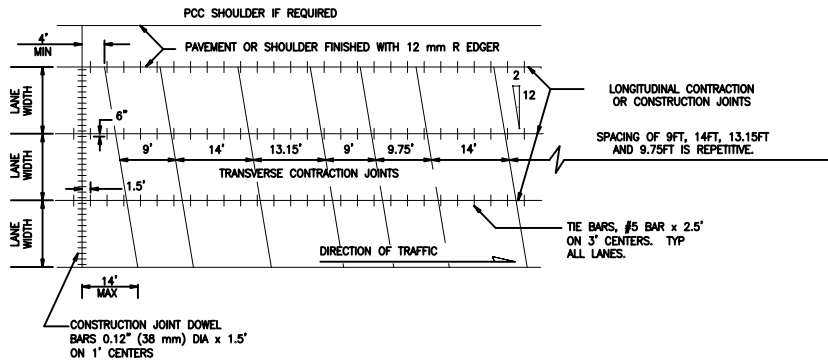

CEMENT CONCRETE PAVEMENT - PLAIN JOINTS

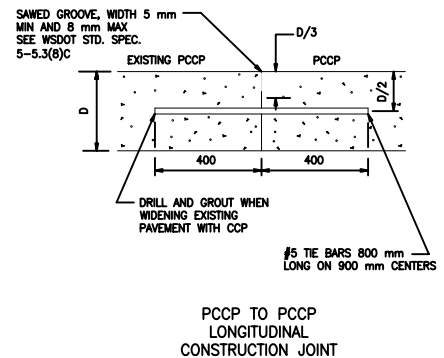
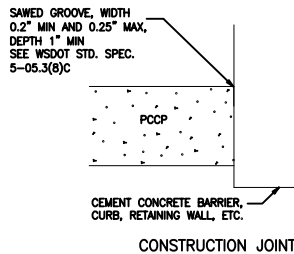
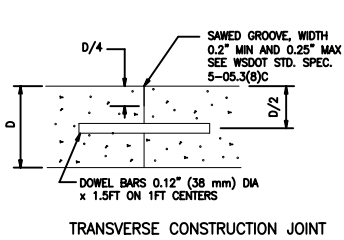
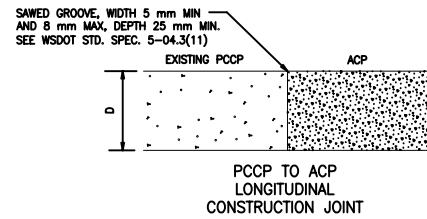
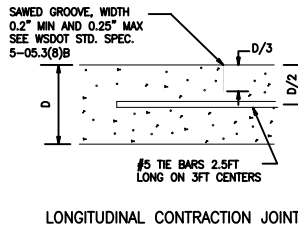
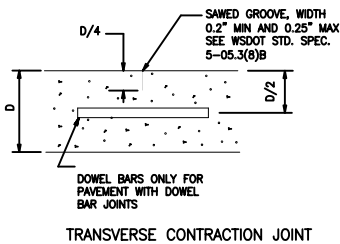

Public Works  
Planning and  
Development  
Services

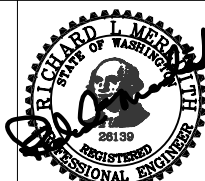

# Rigid Pavement Restoration Details

801

NOT TO SCALE

Revision Date  
December 2006